

Chemglass Life Sciences

Equipment, Glass and Consumables

for Cell and Tissue Culture,
Standard & Chemistry Laboratories

Product Information

- prices on request -



Index

	Page
Adapter for Overhead Drive	11
Adapter for Rotary Evaporators	42
Airfree® products (Adapters, Bubblers, Distillation Apparatus, Schlenk Lines, Vacuum Manifolds, etc.)	41, 45
Aluminum Seals	24
Anaerobic Culture Tubes and Bottles with Aluminum Seals	24 - 25
Anaerobic Stopper for GL45 Flasks	25
B ags, Cell Culture	39
Balch Culture Tubes (Anaerobic)	24
Beakers (Jacketed), Borosilicate Glass	48
Beakers (and Beaker Covers), PTFE	49
Beakers, Stainless Steel	49
BelloCell® Cell Culture System – Cesco Bioengineering	7
BioProcess Spinner Flasks and Accessories	4 - 8
Bioreactor Vessels, Carriers and Accessories	9 - 11, 51 - 52
BioVortexer, Homogenizer Motor and Pestle	30
Bottles	4 - 8, 16, 22 - 26
Anaerobic	25
Hybridization Bottles	26
Media	23
Roller Bottles, Polystyrene	39
Roux Culture Bottles	22
Spinner Flasks und Accessories	4 - 8
Transfer-Media Bottles	16, 23
with Screw Cap, PTFE	50
C aps and Closures (Stainless Steel, Phenolic, Polypropylene, Silicone Sponge, Vented, Stoppers)	17 - 19
Carriers for Spinner Flasks or Bioreactor Vessels	11
Cell Culture Dishes, Plates, Flasks and Bags	20, 39
Bags	39
Dishes with Glass- or Grid Bottom	20
Multi-Well Plates with Glass- or Grid Bottom	20
5-Layer Cell Culture Flask	20
Cell Spreader (Drigalski, L-Shaped), Glass	21
Centrifuge Tubes, Glass or PP (black)	26
Chemistry, selection of laboratory glass and equipment	42 - 46
Chromatography Products – J.G. Finneran	43
Cloning Cylinders	21
Closures and Caps (Stainless Steel, Phenolic, Polypropylene, Silicone Sponge, Vented, Stoppers)	17 - 19
Counting Chamber	21
Cover Slips, round, square or rectangular, “German Glass”, “Float Glass”	27
Crimper for Aluminum Seals	25
Crucible, Porcelain	47
Culture and Shake Flasks	12 - 16
Crystallizing Dishes, PYREX® glass	48
Decapper and Crimper for Aluminum Seals	25
Drigalski Spreader	21
DuoCap, Polycarbonate Erlenmeyer Flasks	13
Dura-Mag™ Magnetic Stirrer, 5 and 9 Positions	32
Dura-Drive™ Overhead Drive, Adapter and Accessories	11, 29
E lectroporation Cuvettes	21
Erlenmeyer, Fernbach and Shake Flasks	12 - 16
Evaporating Dishes, PTFE	50
Filling Bell, Aseptic	22
Filter Funnel with Vacuum Adapter and Stopcock	43, 46
Flasks (Erlenmeyer, Fernbach, DeLong®, Roux, Shake, Spinner, Trypsinizing)	4 - 7, 12 - 16
Funnel, Buchner, Porcelain	47
Funnel, PTFE	43
Frit, glass	10
Gaskets/Septa	19
GL Caps and Pouring Rings, Solid, Open Top, Vented	18 - 19
GlucCell® Glucose Monitoring System	7
H emocytometer	21
Homogenizer	28 - 30
BioVortexer, Motor and Pestles	30
Cell Dissociation Sieves and Mesh Screens	31
Closed System, Plastic, Sterile	30
Dounce, Potter-Elvehjem, Griffiths, Tenbroeck Pyrex® Homogenizer	28 - 29
Overhead Drive	29

	Page
Hungate Culture Tubes (Anaerobic)	24
Hybridization Bottles	26
Impeller Assemblies for Overhead Drives and Spinner Flasks	5, 6, 11
Incubators	40
Jars, PTFE	50
Lab Armor™ Beads, Buckets and Trays (Water and Ice Replacement)	31
Magnetic Stirrer 5-, 6-, 9-, and 15-Positions	32
Media Bottles from Glass, PETG, Polystyrene	23, 25
Membrane/Vented Cap	18
Metallic Beads, Lab Armor™	31
Microwave Reaction Vials	45
Mosquito Feeder	22
Multispot Microscope Slides	30
<hr/>	
Omnitop Sample Tube with Filter and Tubing	16
Open-Top Caps	19
Orbital Shaker, „Versa-Orb“	37
Overhead Drives, Adapters and Accessories	11, 29
Petri Dishes, PYREX® glass	48
Petri Dishes with Compartments	21
Port Assemblies, Stainless Steel	8 - 10
Pouring Rings	19
Pressure Vessels and suitable Bushings	44
Process Reactors (Benchtop and Large Capacity)	52
Reaction Blocks for Vials, NMR Tubes and Flasks	33 - 36
Reciprocating Shaker, „Versa-Shake“	37
Rocker, „Versa-Rock“	37
Roller Apparatus, fixed frame and modular	39 - 40
Roller Bottles, Polystyrene	39
Rotary Evaporator Adapter (for Threaded Vials, Microwave Vials and Pressure Vessels)	42
Roux Culture Flasks	22
Rubber Stoppers	18
<hr/>	
Sample Vials (Clear and Amber Glass)	43
Sampling Vessel	10
Schlenk Lines	41, 45
Screw Caps, Solid or Open Top, with Membrane	17 - 19, 39
Septa/Gaskets	19
Shake Flasks and Transfer Vessels, Glass and Polycarbonate	12 - 16
Shakers and Accessories	37 - 38
Orbital	37
Reciprocating	37
Rocker	37
Trays, Tilting Racks, Sticky Mat, Sticky Tape	38
Silicone Sponge Closures	18
Siphon Assembly, Stainless Steel	8 - 10
Sparger for Bioreactor Vessels	10
Spinner Flasks and Accessories	4 - 8, 11
Spot Plate	22
Spreaders, glass	21
Sticky Mat/Pad and Tape for Rocker and Shaker	38
Stirrers, Magnetic and Stirring Hotplate	32 - 33
Stoppers, Rubber	18
Sublimation Apparatus and Sublimation Flask Adapters	48
<hr/>	
Tissue Grinders	28 - 31
Transfer Media Bottles, Glass, Polycarbonate and PETG	16, 23
Trypsinizing Flasks	16
Tubes: Anaerobic, Balch, Centrifuge	24 - 26
Universal Vent Port Assembly for Side-arms of Spinner Flasks, GL32 and GL45	8
Vacuum Filtration Adapter with or without Stopcock	43, 46
Vacuum Manifolds	45
Vented Caps	18, 39
„Versa“-Laboratory Equipment Series (Rockers, Shakers, Roller Apparatus)	37, 40 - 41
Vials, 4-40 ml, clear and amber glass, Vial Adapters	43
Vials, Microwave Reaction	45
Vial Funnel for Threaded Vials	43
Water Jacketed Spinner Flask, BioProcess	7

Spinner Flasks and Accessories

Spinner Flasks, BioProcess

- For optimal growth of suspension and microcarrier cultures
- Flow dynamic impellers ensure optimal cell suspension even at low speeds
- Several models available: Height adjustable shaft, internal impeller assembly, with or without impeller blade (with magnetic stir bar)
- Slightly domed bottom with or without central dimple (up to 1.000 ml) to prevent cell accumulation
- Side-arm caps GL32 or GL45
- „Complete“ includes flask, PTFE paddle, stir bar, glass shaft and caps with gasket
- All parts are autoclavable at 121 °C
- Height is approximate



BioProcess Spinner Flask, Height Adjustable Shaft, Complete

Cat. No.	Description	Ø Central	Ø Side-arm	Ø x Height
CLS-1430-100	100 ml, central dimple	70 mm	32 mm	70 x 175 mm
CLS-1430-250	250 ml, central dimple	70 mm	32 mm	85 x 210 mm
CLS-1430-500	500 ml, central dimple	70 mm	45 mm	110 x 250 mm
CLS-1430-1L	1.000 ml, central dimple	100 mm	45 mm	135 x 305 mm
CLS-1430-6L	6.000 ml, no dimple	100 mm	45 mm	204 x 410 mm
CLS-1430-8L	8.000 ml, no dimple	100 mm	45 mm	240 x 430 mm

BioProcess Spinner Flask, Without Central Dimple, Height Adjustable Shaft, Complete

Cat. No.	Description	Ø Central	Ø Side-arm	Ø x Height
CLS-1430-F100	100 ml, no dimple	70 mm	32 mm	70 x 175 mm
CLS-1430-F250	250 ml, no dimple	70 mm	32 mm	85 x 210 mm
CLS-1430-F500	500 ml, no dimple	70 mm	45 mm	110 x 250 mm
CLS-1430-F1L	1.000 ml, no dimple	100 mm	45 mm	135 x 305 mm
CLS-1430-F3L	3.000 ml, no dimple	100 mm	45 mm	165 x 355 mm

BioProcess Spinner Flask, Magnetic Stir Bar Only, Height Adjustable Shaft, Complete

Cat. No.	Description	Ø Central	Ø Side-arm	Ø x Height
CLS-1445-100	100 ml, no dimple	70 mm	32 mm	70 x 175 mm
CLS-1445-250	250 ml, no dimple	70 mm	32 mm	85 x 210 mm
CLS-1445-500	500 ml, no dimple	70 mm	45 mm	110 x 250 mm
CLS-1445-1L	1.000 ml, no dimple	100 mm	45 mm	135 x 305 mm
CLS-1445-3L	3.000 ml, no dimple	100 mm	45 mm	165 x 355 mm

BioProcess Spinner Flask, Internal Impeller Assembly, Complete

Cat. No.	Description	Ø Central	Ø Side-arm	Ø x Height
CLS-1450-100	100 ml, central dimple	70 mm	32 mm	70 x 110 mm
CLS-1450-250	250 ml, central dimple	70 mm	32 mm	85 x 145 mm
CLS-1450-500	500 ml, central dimple	70 mm	45 mm	110 x 185 mm
CLS-1450-1L	1.000 ml, central dimple	100 mm	45 mm	135 x 240 mm
CLS-1450-3L	3.000 ml, no dimple	100 mm	45 mm	165 x 290 mm

Replacement parts, impeller assemblies, shafts, caps and port assemblies: see pages 5, 6 and 8

Replacement Spinner Flasks





CLS-1400



CLS-1401

Replacement Spinner Flask includes two side-arm caps only, no central cap

Side-arm caps:
 18 mm caps (25-50 ml):
 black phenolic rubber lined
 GL32 (100-250 ml) and GL45 (≥500 ml):
 blue polypropylene with pouring rings

Replacement Glass Flask with Side-arm Caps only, without Impeller Assembly

Cat. No.	Description	Ø Central	Ø Side-arm	Ø x Height
CLS-1400-25	25 ml, no dimple	38 mm	18 mm	38 x 120 mm
CLS-1400-50	50 ml, no dimple	51 mm	18 mm	55 x 110 mm
CLS-1400-100	100 ml, no dimple	70 mm	32 mm	70 x 110 mm
CLS-1400-250	250 ml, no dimple	70 mm	32 mm	85 x 145 mm
CLS-1400-500	500 ml, no dimple	70 mm	45 mm	110 x 185 mm
CLS-1400-1L	1.000 ml, no dimple	100 mm	45 mm	135 x 240 mm
CLS-1400-3L	3.000 ml, no dimple	100 mm	45 mm	165 x 290 mm
CLS-1400-6L	6.000 ml, no dimple	100 mm	45 mm	204 x 410 mm
CLS-1400-8L	8.000 ml, no dimple	100 mm	45 mm	240 x 430 mm
CLS-1400-15L	15.000 ml, no dimple	100 mm	45 mm	295 x 460 mm
CLS-1401-100	100 ml, central dimple	70 mm	32 mm	70 x 110 mm
CLS-1401-250	250 ml, central dimple	70 mm	32 mm	85 x 145 mm
CLS-1401-500	500 ml, central dimple	70 mm	45 mm	110 x 185 mm
CLS-1401-1L	1.000 ml, central dimple	100 mm	45 mm	135 x 240 mm
CLS-1401-3L	3.000 ml, central dimple	100 mm	45 mm	165 x 290 mm
CLS-1401-6L	6.000 ml, central dimple	100 mm	45 mm	204 x 410 mm
CLS-1401-8L	8.000 ml, central dimple	100 mm	45 mm	240 x 430 mm

Replacement Components for BioProcess Internal Impeller Spinner Flasks



Complete stirring assembly includes:

- top cap
- silicone gasket
- glass shaft
- compression fitting
- paddle
- magnetic stir bar
- magnet holder

Flask size	Ø Central	Impeller Assembly Cat. No.	Glass Shaft Cat. No.
100 ml	70 mm	CLS-1451-01	CLS-1451-40
250 ml	70 mm	CLS-1451-03	CLS-1451-41
500 ml	70 mm	CLS-1451-05	CLS-1451-42
1000 ml	100 mm	CLS-1451-06	CLS-1451-43
3000 ml	100 mm	CLS-1451-07	CLS-1451-44

Suitable Magnetic Stirrers with multiple positions: please see page 32

Replacement Components for BioProcess Spinner Flasks, Height Adjustable Shaft

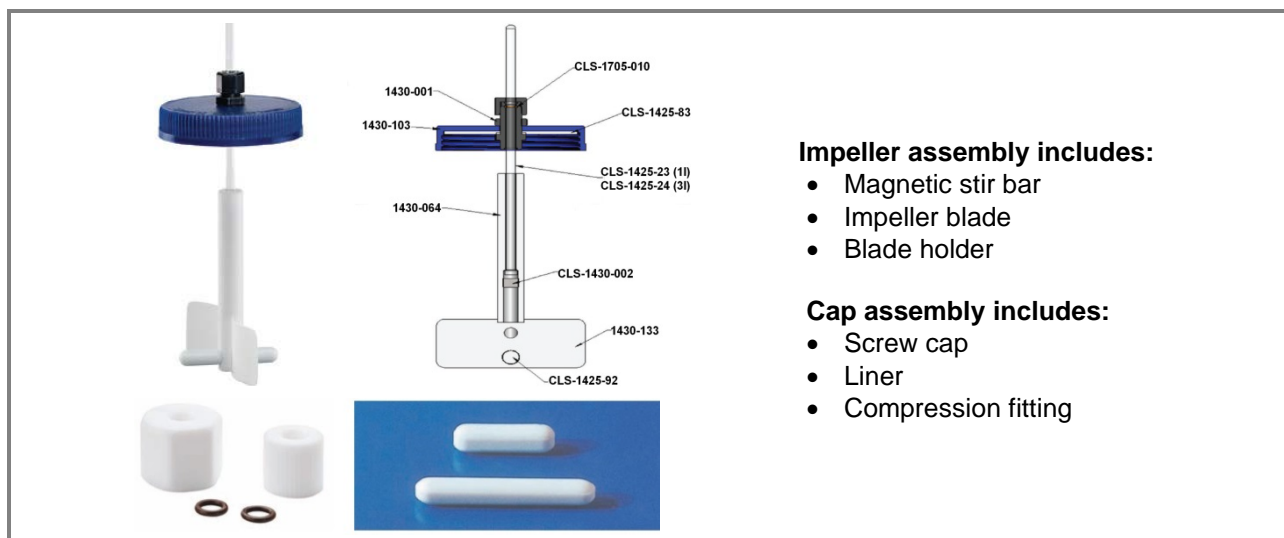

Impeller assembly includes:

- Magnetic stir bar
- Impeller blade
- Blade holder

Cap assembly includes:

- Screw cap
- Liner
- Compression fitting

Cap Assembly

Cat. No.	Description	Cs.
CLS-1425-40	Cap assembly for 25 ml spinner flasks (on request)	1
CLS-1432-41	Cap assembly for 50 ml spinner flasks	1
CLS-1432-42	Cap assembly for 100, 250 and 500 ml BioProcess spinner flasks	1
CLS-1432-43	Cap assembly for 1.000 and 3.000 ml BioProcess spinner flasks	1
CLS-1432-44	Cap assembly for 6.000, 8.000, 15.000 and 36.000 ml BioProcess spinner flasks	1

Glass Shaft Only

Cat. No.	Description	Cs.
CLS-1425-21	Glass shaft for 25 ml, 50 ml, 100 ml and 250 ml spinner flasks, Ø 7 mm	1
CLS-1425-22	Glass shaft for 500 ml spinner flasks, Ø 7 mm	1
CLS-1425-23	Glass shaft for 1.000 ml spinner flasks, Ø 7 mm	1
CLS-1425-24	Glass shaft for 3.000 ml spinner flasks, Ø 7 mm	1
CLS-1425-25	Glass shaft for 6.000 ml, 8.000 ml and 15.000 ml spinner flasks, Ø 9 mm	1
CLS-1425-26	Glass shaft for 36.000 ml spinner flasks, Ø 9 mm	1
CLS-1425-23H	Glass shaft for 1.000 ml spinner flasks CLS-1445 series, Ø 7 mm, CLS-1445 series	1
CLS-1425-24H	Glass shaft for 3.000 ml spinner flasks CLS-1445 series, Ø 7 mm, CLS-1445 series	1

Impeller Assembly

Cat. No.	Description	Cs.
CLS-1431-03	Impeller assembly for 100 - 250 ml BioProcess spinner flasks	1
CLS-1431-05	Impeller assembly for 500 ml BioProcess spinner flasks	1
CLS-1431-06	Impeller assembly for 1.000 – 3.000 ml BioProcess spinner flasks	1
CLS-1431-07	Impeller assembly for 6.000 – 8.000 ml BioProcess spinner flasks	1

Replacement Gaskets

Cat. No.	Description	Cs.
CLS-1425-80	Silicone gasket, for 25 ml spinner flask, 38 mm central cap, white	1
CLS-1425-81	Silicone gasket, for 50 ml spinner flask, 51 mm central cap, white	1
CLS-1425-82	Silicone gasket, for 100 - 500 ml spinner flask, 70 mm central cap, white	1
CLS-1425-83	1.000 - 3.000 ml, Silicone gasket for 100 mm central cap, white, Ø 7 mm	1
CLS-1425-84	6.000 - 36.000 ml, Silicone gasket for central cap, white, Ø 9 mm	1

Replacement Magnetic Stir Bars

Cat. No.	Description	Cs.
CLS-1425-90	Magnetic stir bar for 25 ml spinner flasks	1
CLS-1425-91	Magnetic stir bar for 50 - 500 ml spinner flasks	1
CLS-1425-92	Magnetic stir bar for 1.000 and 3.000 ml spinner flasks	1
CLS-1425-93	Magnetic stir bar for 6.000, 8.000, 15.000 and 36.000 ml spinner flasks	1

Replacement Parts

Cat. No.	Description	Cs.
CLS-1705-010	O-ring for compression fitting, Ø 7 mm	20
CLS-1705-110	O-ring for compression fitting, Ø 9 mm	10
CLS-1430-001	Compression fitting, Ø 7 mm, black	1
CLS-1430-002	Silicone plug, Ø 7 mm	10
CLS-1430-003	Compression fitting, Ø 9 mm, black	1
CLS-1430-004	Silicone plug, Ø 9 mm	10

Spinner Flasks, BioProcess, Water Jacketed, Height Adjustable Shaft



Spinner flask with height adjustable impeller assembly, water jacketed:

- Type 1 Class A Borosilicate Glass
- For use with recirculating water baths
- Jacketed volumes are approximate
- Flasks are not graduated
- Slightly domed bottom without dimple
- Microcarrier style impeller with glass shaft, PTFE paddle and magnetic stir bar
- Flask only does not include any caps

Spinner Flask, Water Jacketed, Complete with Caps and Impeller Assembly

Cat. No.	Description	Ø Central	Ø Side-arm	Jacket Vol.	Ø x Height
CLS-1430-J100	100 ml, no dimple	70 mm	32 mm	75 ml	75 x 160 mm
CLS-1430-J250	250 ml, no dimple	70 mm	32 mm	175 ml	85 x 200 mm
CLS-1430-J500	500 ml, no dimple	70 mm	45 mm	260 ml	110 x 200 mm
CLS-1430-J1L	1.000 ml, no dimple	100 mm	45 mm	875 ml	150 x 255 mm
CLS-1430-J3L	3.000 ml, no dimple	100 mm	45 mm	1.300 ml	200 x 330 mm
CLS-1430-J6L	6.000 ml, no dimple	100 mm	45 mm	3.700 ml	200 x 445 mm

Spinner Flask Only, Water Jacketed, no Caps

Cat. No.	Description	Ø Central	Ø Side-arm	Jacket Vol.	Ø x Height
CLS-1430-J101	100 ml, no dimple	70 mm	32 mm	75 ml	75 x 160 mm
CLS-1430-J251	250 ml, no dimple	70 mm	32 mm	175 ml	85 x 200 mm
CLS-1430-J501	500 ml, no dimple	70 mm	45 mm	260 ml	110 x 200 mm
CLS-1430-J1L1	1.000 ml, no dimple	100 mm	45 mm	875 ml	150 x 255 mm
CLS-1430-J3L1	3.000 ml, no dimple	100 mm	45 mm	1.300 ml	200 x 330 mm
CLS-1430-J6L1	6.000 ml, no dimple	100 mm	45 mm	3.700 ml	200 x 445 mm

BelloCell® Cell Culture Systems & GlucCell® Glucose Monitoring System



BelloCell®

Disposable High-Yield Cell Culture Systems:
For the production of cell mass, cell membrane proteins, monoclonal antibodies, recombinant protein and viruses.



GlucCell®

Glucose Monitoring System:

For glucose measurement from mammalian and insect cell culture media.
Fast and easy-to-use in both serum and serum-free culture medium.
Needs just a sample of 1,5 µl and less than 15 seconds to measure.



Vent Port Assemblies for side-arms of all types of Spinner Flasks



Vent Port Assemblies are supplied with a GL32 or GL45 open top cap and a silicone gasket

Cat. No.	Description	Hose barb size	Ø Side-arm	Cs.
CLS-1429-01	Two port, angled	4,76 mm (3/16")	32 mm	1
CLS-1429-10	One port, straight	6,35 mm (1/4")	45 mm	1
CLS-1429-20	Two port, straight	6,35 mm (1/4")	45 mm	1
CLS-1429-21	Two port, angled (90°)	6,35 mm (1/4")	45 mm	1
CLS-1429-40	Two port, straight	4,00 mm (0,16")	45 mm	1

Replacement Parts

CLS-1481-20	Replacement screw cap, GL32, blue, open top (hole: 2,06 cm)	6
CLS-1481-21	Polypropylene screw cap, GL45, blue, open top (hole: 3,33 cm)	6
CLS-1481-22	Replacement screw cap, green GL45, open top (hole: 3,33 cm)	6
CLS-1481-23	Replacement screw cap, GL45, yellow, open top (hole: 3,33 cm)	6
CLS-1428-11	Replacement silicone gasket, only, white FDA, GL45, open top	1
CLS-1428-13	Replacement silicone gasket, only, GL32, open top	1

Port Assemblies for Spinner Flasks with GL45 side-arms, Stainless Steel (316L)

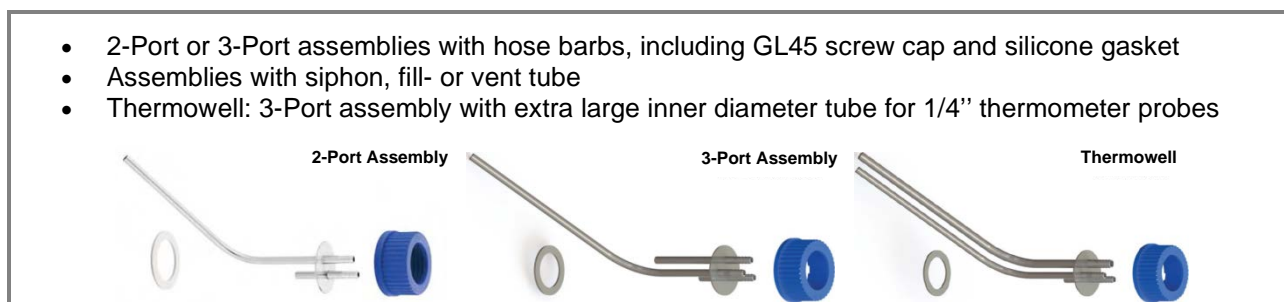

- 2-Port or 3-Port assemblies with hose barbs, including GL45 screw cap and silicone gasket
- Assemblies with siphon, fill- or vent tube
- Thermowell: 3-Port assembly with extra large inner diameter tube for 1/4" thermometer probes

2-port with siphon and vent tube

Cat. No.	Flask size	Longest tube
CLS-1427-01	500 ml	64 mm
CLS-1427-02	1.000 ml	100 mm
CLS-1427-03	3.000 ml	140 mm
CLS-1427-04	6.000 ml	254 mm
CLS-1427-05	8.000 ml	280 mm
CLS-1427-06	15.000 ml	292 mm

3-port with siphon, fill and vent tubes (for addition or sampling of media)

Cat. No.	Flask size
CLS-1427-80	500 ml
CLS-1427-81	1.000 ml
CLS-1427-82	3.000 ml
CLS-1427-83	6.000 ml
CLS-1427-84	8.000 ml
CLS-1427-85	15.000 – 36.000 ml

Thermowell 3-port with siphon, fill and vent tubes (to accommodate thermometers)

Cat. No.	Flask size
CLS-1427-90	1.000 ml
CLS-1427-91	3.000 ml
CLS-1427-92	6.000 ml
CLS-1427-93	8.000 ml
CLS-1427-94	15.000 – 36.000 ml

Bioreactor Vessels and Accessories

- also see pages 51 and 52 -

Bioreactor Vessels with vertical side-arm (VSA)



- Ideal for cell cultivation and fermentation
- For use with Overhead Drives and Magnetic Stirrers
- 4 or 6 vertical side-arms with GL45 opening
- Supplied with side-arm caps and pouring rings
- Without baffles
- 3 and 6 litre vessels have a low profile (reduced vessel height maximizes incubator space)

Cat. No.	Description	Ø Central (GPI)	Ø Side-arm	Ø x Height
CLS-1404-03	3.000 ml, 4 side-arms, low profile	100 mm	45 mm	240 x 250 mm
CLS-1404-06	6.000 ml, 4 side-arms, low profile	100 mm	45 mm	240 x 295 mm
CLS-1404-08	8.000 ml, 4 side-arms	100 mm	45 mm	240 x 425 mm
CLS-1404-15	15.000 ml, 4 side-arms	100 mm	45 mm	295 x 460 mm
CLS-1406-03	3.000 ml, 6 side-arms, low profile	100 mm	45 mm	240 x 250 mm
CLS-1406-06	6.000 ml, 6 side-arms, low profile	100 mm	45 mm	240 x 295 mm
CLS-1406-08	8.000 ml, 6 side-arms	100 mm	45 mm	240 x 425 mm
CLS-1406-15	15.000 ml, 6 side-arms	100 mm	45 mm	295 x 460 mm
CLS-1406-36	36.000 ml, 6 side-arms	100 mm	45 mm	410 x 535 mm

Port Assembly, Stainless Steel

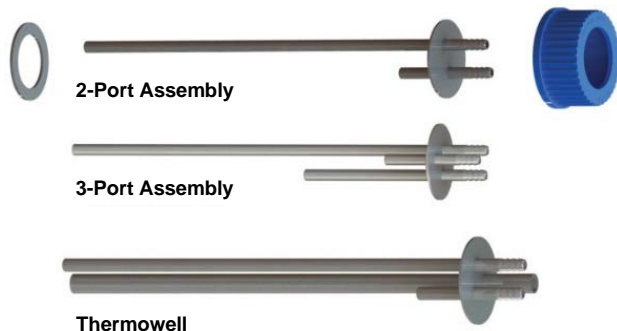

- For Bioreactor Vessel with vertical side-arms or media bottles with GL45 neck
- Stainless steel 316L with 20Ra finish
- 2- or 3-Port assemblies with hose barbs
- With siphon, vent or fill tube
- Thermowell: 3-Port Assembly with 0,31" inner diameter tube for 1/4" thermometer probes
- Harvest tube: 3-Port Assembly with two 1/4" and one 3/8" tubes
- Including 45 mm PP screw cap and silicone gasket

Cat. No. **Bottle Size**

2-Port with siphon and vent tube for:

CLS-1437-19	1.000 ml media bottle
CLS-1437-20	3.000 ml Bioreactor vessel or 2000 ml media bottle
CLS-1437-21	6.000 ml Bioreactor vessel or 5000 ml media bottle
CLS-1437-22	8.000 ml Bioreactor vessel or 10000 ml media bottle
CLS-1437-23	15.000 ml, 36.000 ml Bioreactor vessel

3-Port with siphon, fill and vent tubes for:

CLS-1437-29	1.000 ml media bottle
CLS-1437-30	3.000 ml Bioreactor vessel or 2000 ml media bottle
CLS-1437-31	6.000 ml Bioreactor vessel or 5000 ml media bottle
CLS-1437-32	8.000 ml Bioreactor vessel or 10000 ml media bottle
CLS-1437-33	15.000 ml, 36.000 ml Bioreactor vessel

Thermowell, 3-Port with siphon, vent and large diameter tubes for 1/4" probes for:

CLS-1437-60	3.000 ml Bioreactor vessel
CLS-1437-61	6.000 ml Bioreactor vessel
CLS-1437-62	8.000 ml Bioreactor vessel
CLS-1437-63	15.000 ml, 36.000 ml Bioreactor vessel

Harvest tube, 3-Port with two 1/4" and one 3/8" tubes for:

CLS-1437-70	3.000 ml Bioreactor vessel
CLS-1437-71	6.000 ml Bioreactor vessel
CLS-1437-72	8.000 ml Bioreactor vessel
CLS-1437-73	15.000 ml, 36.000 ml Bioreactor vessel

3-Port Assembly with Sparger



- Stainless steel 316L with 20Ra finish, including 45 mm PP screw cap and silicone gasket
- 3-Port Assembly with hose barbs
- Two models:
 - frit for gentle aeration, 25,4 mm long, 10 µm porosity
 - drilled holes for vigorous aeration
- With siphon, fill and aeration tube
- For vertical side-arm vessels (VSA)

Cat. No.

Bottle Size

3-Port assembly with frit for:

CLS-1437-F50	3.000 ml Bioreactor vessel, VSA
CLS-1437-F51	6.000 ml Bioreactor vessel, VSA
CLS-1437-F52	8.000 ml Bioreactor vessel, VSA
CLS-1437-F53	15.000 ml Bioreactor vessel, VSA
CLS-1437-F54	36.000 ml Bioreactor vessel, VSA
CLS-1437-F75	Frit only, sparger, stainless steel, 25,4 mm long, 10 µm porosity

3-Port assembly with drilled holes for:

CLS-1437-H40	3.000 ml Bioreactor vessel, VSA
CLS-1437-H41	6.000 ml Bioreactor vessel, VSA
CLS-1437-H42	8.000 ml Bioreactor vessel, VSA
CLS-1437-H43	15.000 ml Bioreactor vessel, VSA
CLS-1437-H44	36.000 ml Bioreactor vessel, VSA

Glass Frit



- Increases aeration
- Porosity 40 - 60 µm
- Autoclavable
- Easily attaches to dip tube assemblies with silicone tubing

Cat. No.

Description

CLS-1437-G1	Glass frit, 50 mm length, stem OD 8 mm
-------------	----------------------------------------

Sampling and Addition Vessel with 2-Port Tube Assembly



- Flat bottom glass vessel with 2-port drip tube assembly
- Designed for addition or sampling of media, acid or base
- Port assembly, stainless steel 316L with 20Ra finish
- Hose barbs for attachment of silicone tubing
- Dimensions: 32 mm diameter, 94 mm height
- Includes GL32 screw cap PP and silicone gasket

Cat. No.

Description

Cs.

CLS-1437-B01	Sampling vessel including 2-port assembly, gasket and PP GL32 screw cap	1
CLS-1437-B02	Sampling vessel only, OAL 94 mm, OD 32 mm	1
CLS-1429-02	2-port drip tube assembly with gasket	1
CLS-1428-14	Silicone gasket, white	1
CLS-1481-20	GL32 screw cap, PP, blue, open top	6

Carriers for Bioreactor Vessels and Spinner Flasks



- 304 Stainless steel electropolished
- Allows for easy transport of bioreactor vessels and spinner flasks or large carboys

Cat. No.	Bottle Size	Carboy Size	Ø x Height
CLS-1406-C06	6.000 ml	9 l	203 x 229 mm
CLS-1406-C08	8.000 ml, 3.000 ml / 6.000 ml low profile vessels	13 l	254 x 280 mm
CLS-1406-C15	15.000 ml	19 l	280 x 305 mm
CLS-1406-C36	36.000 ml	45 l	330 x 432 mm

Dura-Drive™ Overhead Motor and Adapters



- For use with stainless steel or PTFE impellers in bioreactor vessels (requires adapter CLS-1440-10)
- Speed range: 5 - 150 rpm
- Torque: 2,15 Nm, 30 W
- Forward and Reverse
- Digital LCD-Display
- Easy mounting bracket (peg & grommet)
- With carrying handle
- Dimensions (wxdxh): 11 x 15 x 20 cm
- Weight: 2,0 kg

Cat. No.	Description
CLS-1440-100E	Dura-Drive™, digital Overhead Drive
CLS-1440-10	Adapter for Overhead Drive, couples motor to PTFE or SST impeller, for 100 mm opening

⇒ **Further Overhead Drives: see page 29**

Impeller Assemblies for Overhead Drive



- Impeller Assemblies PTFE or stainless steel
- Shaft diameter: 19 mm
- Stainless steel assemblies: with pitched blade for improved uplift mixing in vertical side-arm vessels (page 9) supplied with a dust shield and locking ring
- VSA = vertical side-arm

Cat. No.	Vessel Size and Type	Width x Height
PTFE-Impeller Assembly for		
CLS-1440-26	3.000 ml Spinner flask	108 x 222 mm
CLS-1440-27	6.000 ml Spinner flask	171 x 355 mm
CLS-1440-28	8.000 ml Bioreactor vessel, VSA	171 x 337 mm
CLS-1440-29	15.000 ml Bioreactor vessel, VSA	171 x 365 mm
CLS-1440-30	36.000 ml Bioreactor vessel, VSA	241 x 442 mm
CLS-1440-44	3.000 ml Bioreactor vessel, VSA, low profile	171 x 162 mm
CLS-1440-54	6.000 ml Bioreactor vessel, VSA, low profile	171 x 207 mm
SST-Impeller Assembly for		
CLS-1440-P43	3.000 ml Bioreactor vessel, VSA, low profile	165 x 64 mm
CLS-1440-P53	6.000 ml Bioreactor vessel, VSA, low profile	165 x 64 mm
CLS-1440-P48	8.000 ml Bioreactor vessel, VSA	165 x 64 mm
CLS-1440-P49	15.000 ml Bioreactor vessel, VSA	165 x 64 mm
CLS-1440-P50	36.000 ml Bioreactor vessel, VSA	222 x 76 mm

Culture and Shake Flasks

Fernbach Flasks

for culturing organisms that require a large surface area to volume ratio

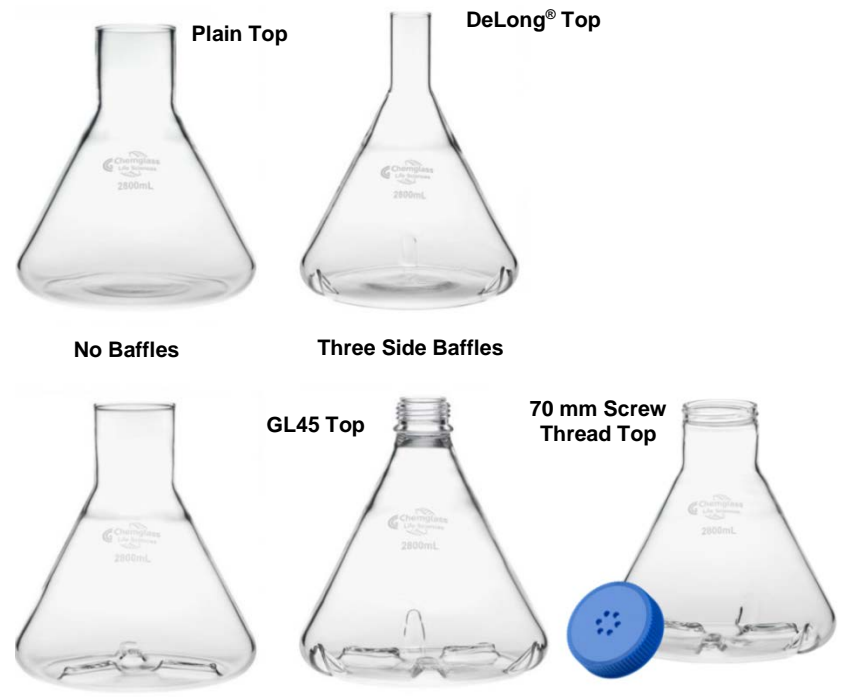

Different designs available:

- No baffles
- Three side baffles
- Three bottom baffles
- Six baffles

Different tops:

- Plain: (59 mm ID)
- DeLong® Neck: (38 mm OD)
- GL45 screw thread top
- 70 mm screw thread top

Screw caps:

- Solid or vented

Volume:

- 2800 ml

Dimensions:

- Ø 210 mm x height 230 mm (DeLong®: height 260 mm)

Material:

- Borosilicate Glass, Type I, Class A

Cat. No.	Description	Cs.
Fernbach flasks without baffle		
CLS-2020-10	Plain top (ID = 59 mm)	1
CLS-2020-11	DeLong® top (OD = 38 mm)	1
CLS-2020-30	Vented screw cap (GL45)	1
CLS-2021-70	Solid screw cap (thread diameter = 70 mm)	1
CLS-2021-72	Vented screw cap (thread diameter = 70 mm)	1
Fernbach flasks with three side baffles		
CLS-2022-14	Plain top (ID = 59 mm)	1
CLS-2022-16	DeLong® top (OD = 38 mm)	1
CLS-2022-31	Vented screw cap (GL45)	1
CLS-2023-72	Vented screw cap (thread diameter = 70 mm)	1
Fernbach flasks with three bottom baffles		
CLS-2024-15	Plain top (ID = 59 mm)	1
CLS-2024-17	DeLong® top (OD = 38 mm)	1
CLS-2024-32	Vented screw cap (GL45)	1
CLS-2025-72	Vented screw cap (thread diameter = 70 mm)	1
Fernbach flasks with six baffles (three side and three bottom baffles)		
CLS-2026-20	Plain top (ID = 59 mm)	1
CLS-2026-22	DeLong® top (OD = 38 mm)	1
CLS-2026-33	Vented screw cap (GL45)	1
CLS-2027-72	Vented screw cap (thread diameter = 70 mm)	1

Erlenmeyer Flasks (Pyrex®)



- Designed from ASTM specification E 1404, Type I, Class 1 requirements
- Narrow neck with reinforced top
- Thick walled body
- White graduation
- To be used with rubber stoppers (page 18)

Cat. No.	Description	Cs.
CG-8496-P25	25 ml, 41 x 65 mm (Ø x H), stopper size 0	1
CG-8496-P50	50 ml, 51 x 75 mm (Ø x H), stopper size 1	1
CG-8496-P125	125 ml, 67 x 114 mm (Ø x H), stopper size 5	1
CG-8496-P250	250 ml, 82 x 132 mm (Ø x H), stopper size 6	1
CG-8496-P300	300 ml, 89 x 144 mm (Ø x H), stopper size 6	1
CG-8496-P500	500 ml, 101 x 176 mm (Ø x H), stopper size 7	1
CG-8496-P1L	1.000 ml, 129 x 216 mm (Ø x H), stopper size 9	1
CG-8496-Pack	5 Flasks in following sizes: 50 ml, 125 ml, 250 ml, 500 ml and 1.000 ml	1

Erlenmeyer Flasks with GL32 or GL45 Screw Cap



- Type 1 Class A Borosilicate Glass
- White graduation
- With screw thread
- Supplied with PP linerless cap and pouring ring

Cat. No.	Description	Cs.
CG-1544-19	125 ml, 120 mm height, screw thread GL32	1
CG-1544-20	250 ml, 130 mm height, screw thread GL45	1
CG-1544-21	500 ml, 170 mm height, screw thread GL45	1
CG-1544-22	1.000 ml, 220 mm height, screw thread GL45	1
CG-1544-23	2.000 ml, 275 mm height, screw thread GL45	1
CG-1544-24	4.000 ml, 340 mm height, screw thread GL45	1

Erlenmeyer Flasks, Sterile, Polycarbonate, with DuoCap®



- Sterile, non-pyrogenic polycarbonate flasks with polypropylene cap
- With molded graduation
- With DuoCap® (available separately)
 - for aerobic and anaerobic applications
 - 0,22 µm pore size PTFE membrane
 - can easily be converted to a solid top design
- Available without baffles or with four side baffles
- Flasks approx. 10 times autoclavable (125 °C)

Cat. No.	Description	Cs.
Without baffles		
CLS-2092-125S	125 ml, 38-430 thread, with blue DuoCap®	24
CLS-2092-250S	250 ml, 38-430 thread, with blue DuoCap®	12
CLS-2092-500S	500 ml, 38-430 thread, with blue DuoCap®	12
CLS-2092-100S	1.000 ml, 53-B thread, with blue DuoCap®	6
CLS-2092-200S	2.000 ml, 53-B thread, with blue DuoCap®	6
With four side baffles		
CLS-2093-125S	125 ml, 38-430 thread, with blue DuoCap®	24
CLS-2093-250S	250 ml, 38-430 thread, with blue DuoCap®	12
CLS-2093-500S	500 ml, 38-430 thread, with blue DuoCap®	12
CLS-2093-100S	1.000 ml, 53-B thread, with blue DuoCap®	6
CLS-2093-200S	2.000 ml, 53-B thread, with blue DuoCap®	6

Bulk packs available on request

Shake Flasks



- Type 1 Class A Borosilicate Glass
- With reinforced top
- Choose between three side baffles or three extra deep side baffles
- To be used with silicone sponge closures (page 18)

Cat. No.	Description	Neck diameter	Cs.
Shake flask, three side baffles			
CLS-2040-01	125 ml, 70 x 115 mm (Ø x H)	25 mm	1
CLS-2040-02	250 ml, 80 x 135 mm (Ø x H)	38 mm	1
CLS-2040-05	1.000 ml, 130 x 215 mm (Ø x H)	38 mm	1
CLS-2040-07	2.000 ml, 155 x 270 mm (Ø x H)	38 mm	1
Shake flask, three extra deep side baffles			
CLS-2042-02	250 ml, 80 x 135 mm (Ø x H)	38 mm	1
CLS-2042-04	500 ml, 100 x 180 mm (Ø x H)	38 mm	1
CLS-2042-05	1.000 ml, 130 x 215 mm (Ø x H)	38 mm	1
CLS-2042-07	2.000 ml, 155 x 270 mm (Ø x H)	38 mm	1



- Type 1 Class A Borosilicate Glass
- With DeLong® neck
- **No** baffles
- Graduated to approximate volumes
- Can be supplied without closure (CLS-2036, please enquire) or with different closures (pages 17-18)

Cat. No.	Description	Neck diameter	Cs.
Shake flask, DeLong® neck, no baffles, including stainless steel closure			
CLS-2038-01	25 ml, 40 x 90 mm (Ø x H)	18 mm	1
CLS-2038-02	50 ml, 50 x 110 mm (Ø x H)	18 mm	1
CLS-2038-03	125 ml, 65 x 145 mm (Ø x H)	25 mm	1
CLS-2038-04	250 ml, 80 x 155 mm (Ø x H)	38 mm	1
CLS-2038-06	500 ml, 100 x 200 mm (Ø x H)	38 mm	1
CLS-2038-07	1.000 ml, 130 x 230 mm (Ø x H)	38 mm	1
CLS-2038-08	2.000 ml, 160 x 280 mm (Ø x H)	38 mm	1
CLS-2038-10	4.000 ml, 205 x 370 mm (Ø x H)	38 mm	1
CLS-2038-11	6.000 ml, 250 x 380 mm (Ø x H)	38 mm	1



- Type 1 Class A Borosilicate Glass
- With DeLong® neck (closures, see pages 17-18)
- Three side baffles
- Graduated to approximate volumes
- Alternatively three **extra deep** side baffles

Cat. No.	Description	Neck diameter	Cs.
Shake flask, DeLong® neck, three side baffles			
CLS-2044-01	50 ml, 50 x 110 mm (Ø x H)	18 mm	1
CLS-2044-02	125 ml, 70 x 145 mm (Ø x H)	25 mm	1
CLS-2044-03	250 ml, 85 x 155 mm (Ø x H)	38 mm	1
CLS-2044-05	500 ml, 100 x 200 mm (Ø x H)	38 mm	1
CLS-2044-06	1.000 ml, 130 x 230 mm (Ø x H)	38 mm	1
CLS-2044-08	2.000 ml, 155 x 300 mm (Ø x H)	38 mm	1
Shake flask, DeLong® neck, three extra deep side baffles			
CLS-2046-01	50 ml, 50 x 110 mm (Ø x H)	18 mm	1
CLS-2046-02	125 ml, 70 x 145 mm (Ø x H)	25 mm	1
CLS-2046-03	250 ml, 85 x 155 mm (Ø x H)	38 mm	1
CLS-2046-04	300 ml, 88 x 162 mm (Ø x H)	38 mm	1
CLS-2046-05	500 ml, 100 x 200 mm (Ø x H)	38 mm	1
CLS-2046-06	1.000 ml, 130 x 230 mm (Ø x H)	38 mm	1
CLS-2046-08	2.000 ml, 155 x 300 mm (Ø x H)	38 mm	1
CLS-2046-10	4.000 ml, 205 x 370 mm (Ø x H)	38 mm	1

Shake Flasks (continued)



- Type 1 Class A Borosilicate Glass
- With DeLong® neck (closures, see pages 17-18)
- Six baffles: three side baffles, three bottom baffles
- Alternatively four bottom baffles with constriction to prevent splashing from reaching the closure

Cat. No.	Description	Neck diameter	Cs.
Shake flask, DeLong® neck, six baffles, three side baffles and three bottom baffles			
CLS-2048-04	250 ml, 80 x 155 mm (Ø x H)	38 mm	1
CLS-2048-05	500 ml, 100 x 200 mm (Ø x H)	38 mm	1
CLS-2048-06	1.000 ml, 130 x 230 mm (Ø x H)	38 mm	1
CLS-2048-08	2.000 ml, 155 x 300 mm (Ø x H)	38 mm	1
CLS-2048-09	3.000 ml, 185 x 340 mm (Ø x H)	38 mm	1
CLS-2048-10	4.000 ml, 205 x 370 mm (Ø x H)	38 mm	1
Shake flask, DeLong® neck, four bottom baffles, with constriction below the neck			
CLS-2050-02	250 ml, 80 x 155 mm (Ø x H)	38 mm	1
CLS-2050-04	500 ml, 100 x 200 mm (Ø x H)	38 mm	1
CLS-2050-06	1.000 ml, 130 x 230 mm (Ø x H)	38 mm	1



- Type 1 Class A Borosilicate Glass
- With screw thread for vented GL32 or GL45 screw caps (0,22 µm PTFE-membrane)
- The flasks can be autoclaved with the cap attached
- Three side baffles or six baffles (three side and three bottom baffles)
- Supplied with 0,22 µm PTFE-membrane vented cap, PP

Cat. No.	Description	Screw cap size	Cs.
Shake flask, screw thread, three side baffles			
CLS-2051-02	125 ml, 65 x 120 mm	GL32	1
CLS-2051-04	250 ml, 80 x 125 mm	GL45	1
CLS-2051-06	500 ml, 100 x 170 mm	GL45	1
CLS-2051-08	1.000 ml, 130 x 215 mm	GL45	1
CLS-2051-10	2.000 ml, 170 x 270 mm	GL45	1
Shake flask, screw thread, six baffles			
CLS-2052-04	250 ml, 80 x 125 mm	GL45	1
CLS-2052-06	500 ml, 100 x 170 mm	GL45	1
CLS-2052-08	1.000 ml, 130 x 215 mm	GL45	1
CLS-2052-10	2.000 ml, 170 x 270 mm	GL45	1
CLS-1484-32	Blue vented cap, PP, 0,22 µm PTFE-membrane, GL32, non sterile		5
CLS-1484-10	Grey vented cap, PP, 0,22 µm PTFE-membrane, GL45, non sterile		1
CLS-1484-12	Blue vented cap, PP, 0,20 µm ePTFE-membrane, GL45, non sterile		5



- Type 1 Class A Borosilicate Glass
- 70 mm inner diameter screw thread
- Solid or vented screw cap with 0,20 µm PVDF-membrane
- Capacity: 2 litres
- Six bottom baffles

Cat. No.	Description	Cs.
CLS-2054-04	2.000 ml, 170 x 270 mm, supplied with 70 mm vented cap	1
CLS-2054-06	2.000 ml, 170 x 270 mm, supplied with 70 mm solid cap	1

Shake Flasks and Transfer Vessels made of Polycarbonate, Sterile



- Erlenmeyer and Fernbach flasks from Polycarbonate
- Flat or baffled bottom
- Available as 3.000 ml transfer vessel with barbed hose fitting to accept 1/8" inner diameter weldable C-Flex® tubing ending (includes tubing clamp)
- Autoclavable
- 70 mm cap included
- Individually packed, gamma irradiated

Cat. No.	Description	Cs.
CLS-2170-EP2L	Erlenmeyer flask, 2.000 ml, flat bottom	6
CLS-2170-FP2L	Fernbach flask, 2.000 ml, flat bottom	6
CLS-2170-FP3L	Fernbach flask, 3.000 ml, flat bottom	4
CLS-1171-3LP / CLS-1171-3LB	Transfer vessel (Fernbach style), 3.000 ml, plain (-3LP) or baffled (-3LB) bottom, with barbed hose fitting, weldable C-Flex® tubing and tubing clamp, plugged	1
CLS-2171-EB2L	Erlenmeyer flask, 2.000 ml, baffled bottom	6
CLS-2171-FB2L	Fernbach flask, 2.000 ml, baffled bottom	6
CLS-2171-FB3L	Fernbach flask, 3.000 ml, baffled bottom	4
CLS-2172-V070	Vented cap, PP, 70 mm	24
CLS-2072-S070	Solid cap, HDPE, 70 mm	24

Omnitop Sample Tubes with Filter and Tubing, Sterile



- Convenient tubes to be used to obtain fluid samples and for transfer of products in a closed system, single-use
- To be aseptically connected to your bioreactor or other device, variants available with or without internal silicone dip tube
- With pre-attached 0,2 µm vent filter and 46 cm of C-Flex® tubing

Cat. No.	Description	Cs.
CLS-1407-T-015	Omnitop sample tubes, 15 ml, polypropylene, with C-Flex® Inlet tubing	10
CLS-1407-T-115	Omnitop sample tubes, 15 ml, polystyrene, with C-Flex® Inlet tubing	10
CLS-1407-T-10	Omnitop samples tubes, 50 ml, with silicone dip tube, C-Flex® Inlet, seal tube	10
CLS-1407-T-12	Omnitop samples tubes, 50 ml, with silicone dip tube, C-Flex® Inlet tubing	10

Trypsinizing Flask



- Type 1 Class A Borosilicate Glass
- 4 deep side baffles for optimum agitation
- Beaded, break-resistant lip
- 50 mm OD neck

Cat. No.	Description	Cs.
CLS-2058-02	2.000 ml, 158 x 290 mm (Ø x H)	1
CLS-2058-04	4.000 ml, 205 x 360 mm (Ø x H)	1

Transfer Media Bottle



- Type 1 Class A Borosilicate Glass (Duran)
- Hose barb outlet at the bottom for easy gravity transfer of solutions
- Pouring ring and GL45 vented cap included

Cat. No.	Description	Cs.
CLS-1423-100	100 ml, hose barb for ¼" ID tubing	1
CLS-1423-250	250 ml, hose barb for ¼" ID tubing	1
CLS-1423-500	500 ml, hose barb for ¼" ID tubing	1
CLS-1423-1L	1.000 ml, hose barb for ¼" ID tubing	1
CLS-1423-2L	2.000 ml, hose barb for ¼" ID tubing	1
CLS-1423-5L	5.000 ml, hose barb for ¼" ID tubing	1
CLS-1423-10L	10.000 ml, hose barb for ½" ID tubing	1

Closures made of Stainless Steel (SST) or Polypropylene (PP)



- Ideal for use with culture tubes or flasks with DeLong® neck
- 305 stainless steel or polypropylene
- SST closures with finger grips for firm fit
- PP closures with two positions, open for gas exchange or closed for humidified environment
- SST closures autoclavable and dry heat sterilizable, PP closures autoclavable to 121 °C

Cat. No.	Size (Ø)	Material	Cs.
Stainless steel closures with fingers			
CLS-1502-018	18 mm	Stainless Steel	10
CLS-1502-025	25 mm	Stainless Steel	10
CLS-1502-038	38 mm	Stainless Steel	10
Polypropylene closures with two positions			
CLS-1503-09	25 mm	Polypropylene	10
CLS-1503-10	38 mm	Polypropylene	10

Polypropylene Caps



- Polypropylene
- Ridges inside cap provide secure grip and gas exchange
- Caps provide same evaporation and sterility benefits as stainless steel closures
- Autoclavable
- Available in five sizes (13, 16, 18, 20 mm and 38 mm) and five colours (blue, green, clear, red and yellow) (Please enquire for colours not listed below)

Cat. No.	Size (Ø)	Colour	Cs.
CLS-1504-13G	13 mm	green	100
CLS-1504-13R	13 mm	red	100
CLS-1504-16G	16 mm	green	100
CLS-1504-16R	16 mm	red	100
CLS-1504-18G	18 mm	green	100
CLS-1504-18R	18 mm	red	100
CLS-1504-20G	20 mm	green	100
CLS-1504-20R	20 mm	red	100
CLS-1504-25G	25 mm	green	100
CLS-1504-25R	25 mm	red	100

Phenolic Screw Caps, Corning®



- Caps are fabricated of a resin specially formulated to resist the effects of temperature and steam in autoclaving
- Available with a glued-in rubber liner without and with PTFE interface to provide a highly inert sealing face

Cat. No.	Thread size	Liner	Cs.
CG-8750-13	13-415	PTFE	288
CG-8750-15	15-415	PTFE	288
CG-8750-24	24-400	PTFE	12
CG-8752-132	13-415	Rubber	288
CG-8752-182	18-415	Rubber	192
CG-8752-24	24-400	Rubber	12
CG-8752-40	40-400	Rubber	72

Additional thread sizes can be offered on request

Rubber Stoppers



- Suitable for practically all laboratory uses
- Compositions ensures resiliency and pliability over a long period and withstands laboratory conditions without hardening
- In accordance with specifications established by the N.B.S.
- Low in free sulfur (1/2 %)
- Autoclavable at 121 °C (no dry heat)

Cat. No.	Size	Top Ø (mm)	Bottom Ø (mm)	Length (mm)	Cs.
CG-3026-03	0	17	13	25	12
CG-3026-04	1	19	14	25	12
CG-3026-06	3	24	18	25	12
CG-3026-08	5	27	23	25	12
CG-3026-10	6	32	26	25	12
CG-3026-12	7	37	30	25	12
CG-3026-16	9	45	37	25	6
CG-3026-22	12	64	54	25	3
CG-3026-26	15	103	83	39	1

Rubber stoppers in other sizes, with one or two holes, with twist-off seals and septum stoppers available

Closures, Silicone Sponge



- Silicone sponge sealed in a silicone rubber ring
- Flange fits snugly over necks permitting gas exchange whilst reducing evaporation
- Ideal for aerobic cultures
- Withstand heat sterilization up to 180 °C and autoclaving

Cat. No.	For use with:	Cs.
CLS-1490-013	13 - 18 mm culture tubes, 18 mm screw necks	10
CLS-1490-020	18 - 25 mm culture tubes, 25 - 50 ml Erlenmeyer flasks, 25 - 125 ml DeLong® flasks	10
CLS-1490-028	125 - 300 ml Erlenmeyer flasks	10
CLS-1490-038	38 mm culture tubes and DeLong® flasks, 500 – 1.000 ml Erlenmeyer flasks, GL45 screw threads	10

Vented Screw Cap



- Polypropylene (PP) screw cap
- GL25, GL32 and GL45 or 70 mm
- Vented (membrane: see below)
- Non-sterile
- Autoclavable at 121 °C

Cat. No.	Material/Description	Membrane	Cs.
CLS-1484-10	Vented cap, PP, GL45, grey	PTFE, 0.22 µm	1
CLS-1484-12	Vented cap, PP, GL45, blue, 3 large vent holes	ePTFE, 0.20 µm	5
CLS-1484-25	Vented cap, PP, GL25, blue	PTFE, 0.22 µm	5
CLS-1484-32	Vented cap, PP, GL32, blue	PTFE, 0.22 µm	5
CLS-1484-A-70	Vented cap, PP, 70 mm, blue (needs silicone gasket)	PTFE, 0.22 µm	1
CLS-1484-A-72	Silicone gasket only, for 70 mm vented cap		1

Caps, GL Thread, Solid



- GL25, GL32, GL45, 70 mm or 100 mm
- Different materials for different temperatures
- Polypropylene caps available in additional colours
- Clear caps to avoid risk of leaching

Cat. No.	Material/Description	Thread	Temperature	Colour	Cs.
Screw caps					
CLS-1480-10	Polypropylene Cap	GL25	up to 140 °C	blue	10
CLS-1480-11	Polypropylene Cap	GL32	up to 140 °C	blue	10
CLS-1480-12	Polypropylene Cap	GL32	up to 140 °C	orange	10
CLS-1486-01	PBTE cap with PTFE seal	GL32	-45 °C to 200 °C	red	1
CLS-1480-13SC	Polypropylene Cap	GL45	up to 140 °C	blue	10
CLS-1480-15	Polypropylene Cap	GL45	up to 140 °C	green	10
CLS-1480-16	Polypropylene Cap	GL45	up to 140 °C	orange	10
CLS-1483-10	Polypropylene SURE-LINK™ Cap with bonded PTFE/Silicone septum	GL45	up to 121 °C	white	10
CLS-1486-02	PBTE cap with PTFE seal	GL45	-45 °C to 200 °C	red	1
CLS-1480-19	TpCh260 (similar to PFA) cap with PTFE-coated silicone seal, compliant to USP Class VI	GL45	-196 °C to 260 °C	clear	5
CLS-1480-20	Fluoropolymer (PFA 6515 TZ) with lip molded seal, compliant to USP Class VI	GL45	-196 °C to 260 °C	clear	5
Screw caps 70 mm and 100 mm					
CLS-1487-70	70 mm (to be used with liner CLS-1487-72)		up to 121 °C	blue	1
CLS-1487-72	Silicone liner only, for 70 mm cap				1
CLS-1487-100	100 mm (to be used with liner CLS-1487-102)		up to 121 °C	blue	1
CLS-1487-102	Silicone liner only, for 100 mm cap				1

Pouring Rings



- Polypropylene, autoclavable at 140 °C, additional colours available
- Ethylene Tetrafluoroethylene (ETFE), red, autoclavable to 180 °C

Cat. No.	Material/Description	Thread	Temperature	Colour	Cs.
CLS-1482-11	Polypropylene Pouring Rings	GL32	up to 140 °C	blue	10
CLS-1482-12	Polypropylene Pouring Rings	GL32	up to 140 °C	clear	10
CLS-1482-13	Polypropylene Pouring Rings	GL45	up to 140 °C	blue	10
CLS-1482-14	Polypropylene Pouring Rings	GL45	up to 140 °C	green	10
CLS-1482-17	Polypropylene Pouring Rings	GL45	up to 140 °C	clear	10
CLS-1482-30	ETFE Pouring Rings	GL45	up to 180 °C	red	10

Open Top Cap, GL Thread, Polypropylene



- Polypropylene, autoclavable at 140 °C, additional colours available
- To be used with port assemblies (pages 8-10) or PTFE Septa (see below)

Cat. No.	Material/Description	Thread	Temperature	Colour	Cs.
Open Top Caps, screw thread					
CLS-1481-20	Open top cap, hole 2,06 cm Ø	GL32	up to 140 °C	blue	6
CLS-1481-21	Open top cap, hole 3,33 cm Ø	GL45	up to 140 °C	blue	6
CLS-1481-22	Open top cap, hole 3,33 cm Ø	GL45	up to 140 °C	green	6
PTFE Septa for open top caps					
CG-196-13	PTFE Septa for GL32 Caps				1
CG-196-14	PTFE Septa for GL45 Caps				1

Cell Culture Dish with Glass Bottom, Sterile



- Glass bottom dish for microscopy and live-cell imaging
- Optical grade glass thickness: 0,16-0,19 mm
- Sterilized by use of E-beam

Cat. No.	Description	Cs.
CLS-1811-001	Cell Culture Dish with glass bottom, 35 x 10 mm, 15 mm glass diameter	10
CLS-1811-002	Cell Culture Dish with glass bottom, 35 x 10 mm, 20 mm glass diameter	10

Multi-Well Cell Culture Plates with Glass Bottom, Sterile

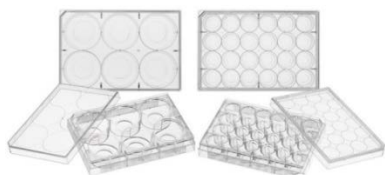

- Glass bottom culture plates for microscopy and live-cell imaging in standard size 6- and 24-well format
- Optical grade glass thickness: 0,16-0,19 mm
- Sterile, non-cytotoxic, non-pyrogenic

Cat. No.	Description	Cs.
CLS-1812-006	Cell Culture Plate with glass bottom, 6-well, 20 mm glass diameter	1
CLS-1812-024	Cell Culture Plate with glass bottom, 24-well, 10 mm glass diameter	1

Cell Culture Dish with Gripping Ring, Polystyrene, TC, Sterile



- Flat, transparent surfaces
- Numeric marks allow for an easy identification of the location of cells
- For cell cultivation and for microscopic analyses
- High Clarity Polystyrene
- Tissue culture treated for optimum cell adhesion
- Stackable, non-pyrogenic
- Sterilized by e-beam

Cat. No.	Description	Cs.
CGN-1805-035GR	35 mm Cell Culture Dishes, with gripping ring, sterile, 20 inner package, 500/cs.	500

5-Layer Cell Culture Flasks with Vented Cap, Sterile



- Cell culture flasks with 5 layers provide a cell growth area of 875 cm²
- Tissue culture treated for optimum cell adhesion
- Supplied with a vented cap
- Sterile, non-pyrogenic and individually wrapped

Cat. No.	Description	Cs.
CGN-2404-V01	5-Layer Cell Culture Flask, sterile (replaces cat. number CLS-2404-V-01)	8

Cell Culture Flasks with Vented Cap, Sterile



- Cell culture flasks (1 layer) with cell growth area of 25 - 225 cm²
- Tissue culture treated for optimum cell adhesion
- Supplied with a vented cap
- Sterile, non-pyrogenic, DNase/RNase-free

Cat. No.	Description	Cs.
CGN-2406-125	25cm ² Cell Culture Flask, TC, Vent Cap, Sterile, 10 inner package, 200/cs.	200
CGN-2406-750	75cm ² Cell Culture Flask, TC, Vent Cap, Sterile, 5 inner package, 100/cs.	100
CGN-2406-175	175cm ² Cell Culture Flask, TC, Vent Cap, Sterile, 5 inner package, 40/cs.	40
CGN-2406-225	225cm ² Cell Culture Flask, TC, Vent Cap, Sterile, 5 inner package, 25/cs.	25

Cloning Cylinders



- Type 1 Class A Borosilicate Glass
- To clone single cells or subpopulations in a tissue culture dish
- Can be autoclaved or dry heat sterilized

Cat. No.	OD	Height	Cs.
CLS-1777-01	6 mm	8 mm	125
CLS-1777-02	8 mm	8 mm	125
CLS-1777-03	10 mm	10 mm	125

Disposable Hemocytometer, C-Chip™, Plastic

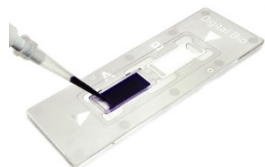

- Grid: Neubauer Improved
- 10 µl sample volume
- Dimensions: 25 x 75 x 1,6 mm, Chamber depth: 100 µm
- 50 chips = 100 tests per box

Cat. No.	Description	Cs.
CLS-4207-01	Disposable Hemocytometer, C-Chip™	50

Electroporation Cuvettes



- Bridge Electroporation Cuvettes efficiently transfer DNA and siRNA into a wide variety of cell types
- Available in three gap widths to choose the correct cuvette size for your application
- Cuvettes fit in most manufacturer's systems including those from Bio-Rad®, Invitrogen®, Eppendorf and Kodak®/IBI®

Cat. No.	Description	Cs.
CLS-1370-01	Electroporation Cuvettes, 1 mm gap width	50
CLS-1370-02	Electroporation Cuvettes, 2 mm gap width	50
CLS-1370-03	Electroporation Cuvettes, 4 mm gap width	50

Petri Dishes with Compartments, Sterile



- Petri dishes with compartments for bacterial culture
- Three vents for gas exchange
- Sterilized by E-Beam, DNase-/RNase-free, non-pyrogenic
- Non-treated, high clarity polystyrene

Cat. No.	Description	Cs.
CLS-1804-02	Petri Dish, 2 Compartments, sterile	20
CLS-1804-03	Petri Dish, 3 Compartments, sterile	20
CLS-1804-04	Petri Dish, 4 Compartments, sterile	20

*Bulk packs
available on request*

Glass Cell Spreader, Drigalski and L-Shaped

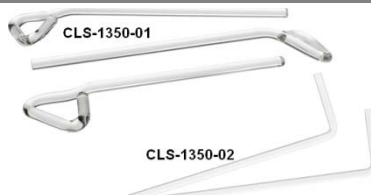

- Manufactured from 5 mm Ø Borosilicate Glass tubing
- Ideal for spreading on agar
- Two styles available:
120° bend (Drigalski) and 90° bend (L-Shape)

Cat. No.	Description	Cs.
CLS-1350-01	Cell spreader, bend 120° (Drigalski)	10
CLS-1350-02	Cell spreader, bend 90° (L-Shaped)	10

Roux Culture Flask



- Type 1 Class A Borosilicate Glass
- Offset neck prevents cultures from entering the neck area
- Supplied with 38-415 rubber lined phenolic closure
- Total volume 1.200 ml
(will hold about 1/2 volume when laid down flat)

Cat. No.	Description	Cs.
CLS-1195-1200	1.200 ml, 290 x 122 x 56 mm (L x W x H)	1

Filling Bell, Aseptic



- Type 1 Class A Borosilicate Glass
- Tubing is attached to the serrated hose connection
- Receiving vessel is placed inside the bell
- Different sizes available

Cat. No.	ID of Bell / Height	Cs.
CLS-1187-52	49 mm / 100 mm	1
CLS-1187-53	70 mm / 125 mm	1
CLS-1187-54	104 mm / 130 mm	1

Spot Plate



- Pyrex® Type 1 Class A Borosilicate Glass
- 9 concave depressions which are useful for soil chemistry, colour reactions, microchemical applications and microscopic observations
- Depressions: 22 x 7 mm (Ø x Depth)

Cat. No.	Description	Cs.
CG-8712-85	Spot plate, 9 concave depressions, 85 x 100 mm	6

Mosquito Feeder

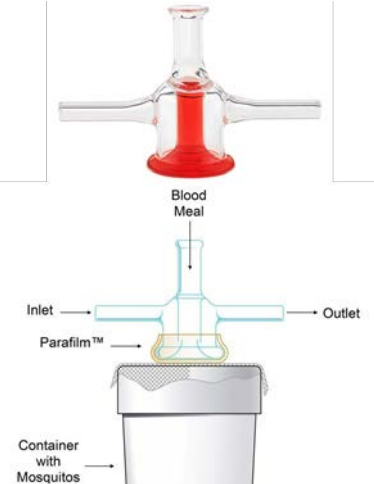

- Glass mosquito feeder with an outer chamber for circulation of 37 °C water and inner chamber to inject the blood
- Small feeder: 14 mm diameter feeding area
18 mm outer diameter of blood chamber
4 mm outer diameter connections
- Large feeder: 50 mm diameter feeding area
56 mm outer diameter of blood chamber
10 mm outer diameter connections

References:

Das S et al., Protocol for Mosquito Rearing. J Vis Exp., 2007

Cosgrove JB et al., A convenient mosquito membrane feeding system. J Am Mosq Control Assoc, 1994

Kasap H et al., Artificial blood feeding of Anopheles sacharovi on a membrane apparatus. J Am Mosq Control Assoc, 2003

Cat. No.	Description	Cs.
CG-1835-70	Mosquito feeder, glass, small, feeding area 14 mm diameter, membrane style	1
CG-1836-75	Mosquito feeder, glass, large, feeding area 50 mm diameter, membrane style	1

Media Bottles made of PETG and Polystyrene

Media Bottles made of PETG, Square Form, Sterile



- Bottles from optically clear, break-resistant PETG, provide reduced permeability to CO₂ and O₂
- Square bottles with rounded edges to ensure an easy grip for pouring
- Cap from polyethylene (HDPE) with security ring, which provides a tamper-evident seal, liner-free
- Freezable at -20 °C
- DNase-/RNase-free, non-pyrogenic
- Sterilized by gamma irradiation, not autoclavable

Cat. No.	Description	Cs.
CLS-1150-0030	Square media bottle, 30 ml, sterile, PETG, graduated, 20-415 thread	24
CLS-1150-0060	Square media bottle, 60 ml, sterile, PETG, graduated, 20-415 thread	24
CLS-1150-0125	Square media bottle, 125 ml, sterile, PETG, graduated, 38-430 thread	24
CLS-1150-0250	Square media bottle, 250 ml, sterile, PETG, graduated, 38-430 thread	24
CLS-1150-0500	Square media bottle, 500 ml, sterile, PETG, graduated, 38-430 thread	12
CLS-1150-1000	Square media bottle, 1.000 ml, sterile, PETG, graduated, 38-430 thread	12
CLS-1150-2000	Square media bottle, 2.000 ml, sterile, PETG, graduated, 53-B thread	6

Media Transfer Bottle made of PETG with 2-Port Assembly, Sterile



- Media transfer bottle made of PETG with a 2-port closure assembly which includes
 - one polypropylene cap
 - one V-notched dip tube
 - one 0.22 µm vented filter
 - one 60 cm long tubing with a plugged end
 - one 1/4" pinch clamp
- Made from pharmaceutical grade thermoplastic elastomer, USP Class VI approved
- Sterilized by gamma irradiation and packed individually in a class 7 cleanroom, single-use

Cat. No.	Description	Cs.
CLS-1168-0125	Media Transfer Bottle with 2-Port Assembly, 125 ml, sterile, PETG	10
CLS-1168-0250	Media Transfer Bottle with 2-Port Assembly, 250 ml, sterile, PETG	10
CLS-1168-0500	Media Transfer Bottle with 2-Port Assembly, 500 ml, sterile, PETG	5
CLS-1168-1000	Media Transfer Bottle with 2-Port Assembly, 1.000 ml, sterile, PETG	5
CLS-1168-2000	Media Transfer Bottle with 2-Port Assembly, 2.000 ml, sterile, PETG	5

Media Bottles made of Polystyrene, Sterile



- Bottles made of polystyrene with heavy wall construction have a concave shape and knurled cap for easy handling
- With engraved graduations
- DNase-/RNase-free
- Sterilized by gamma irradiation and packed individually

Cat. No.	Description	Cs.
CLS-1152-0150	Media bottle, 150 ml, sterile, polystyrene, graduated	24
CLS-1152-0250	Media bottle, 250 ml, sterile, polystyrene, graduated	24
CLS-1152-0500	Media bottle, 500 ml, sterile, polystyrene, graduated	24
CLS-1152-1000	Media bottle, 1.000 ml, sterile, polystyrene, graduated	24

Anaerobic Culture Tubes and Bottles

Hungate Anaerobic Culture Tubes, Screw Thread



- Tubes from Borosilicate glass for anaerobic culture conditions
- The technique developed by Hungate et al. is ideal for cultivation of anaerobic microorganism
- Hungate tubes complete consist of following items:
 - a) Screw cap with a 9 mm opening
 - b) Flange style stopper from grey butyl rubber
 - c) 16 x 125 mm screw thread style tube designed to maintain anaerobic conditions

Lit.: "Use of Syringe Methods for anaerobics"; J.M. Macy, J.E. Snellen and R.E. Hungate. J. Clin. Nutrition, Dec. 1972.

Cat. No.	Description	Dimensions	Cs.
CLS-4208-01	Hungate Tubes complete, incl. butyl rubber stoppers and screw caps	16 x 125 mm	100
Replacement components			
CLS-4208-10	Hungate glass tubes	16 x 125 mm	100
CLS-4208-11	Open top screw caps	Opening: 9 mm	100
CLS-4208-12	Grey butyl rubber stoppers	Height: 5,4 mm	100

Balch Anaerobic Culture Tubes, Aluminum Seals, Stoppers



- Aluminium crimp seal for a more secure seal than with screw caps
- Especially suited for studies with over pressures between 2 - 3 bar
- Blue butyl rubber stoppers are heavier than septa and more capable to withstand repeated piercings
- Culture tubes complete consist of following items:
 - a) 20 mm Aluminum Crimp Seal blue butyl rubber
 - b) Flange style stopper made from
 - c) 18 x 150 mm crimp style Borosilicate glass tube designed to maintain anaerobic conditions
- Crimper and Decapper for aluminum seals (see page 25)

Cat. No.	Description	Dimensions	Cs.
CLS-4209-01	Anaerobic tubes complete, incl. blue butyl stoppers and aluminum seals	18 x 150 mm	100
Replacement components			
CLS-4209-10	Glass tubes	18 x 150 mm	100
CLS-4209-12	Aluminum seals with 9 mm opening	Outer Ø: 20 mm	100
CLS-4209-14	Blue butyl rubber stoppers	Height: 14,5 mm / Inner Ø: 13,6 mm	100

Anaerobic Bottles



- Bottles for anaerobic cultivation or media storage
- Gas tight blue butyl rubber stoppers as for Balch tubes (CLS-4209-01, page 24)
- Manufactured from Borosilicate Glass
- Anaerobic media bottle CLS-4217 supplied with butyl rubber stopper (CLS-4209-14) and aluminum seal (CLS-4209-12)

CLS-4215 CLS-4217

Cat. No.	Description	Cs.
CLS-4215-03	Anaerobic culture bottle, 500 ml, single neck	1
CLS-4215-05	Anaerobic culture bottle, 1.000 ml, single neck	1
CLS-4215-01	Anaerobic culture bottle, 2.000 ml, two necks	1
CLS-4217-01	Anaerobic media bottle, 50 ml, graduated	1
CLS-4217-02	Anaerobic media bottle, 100 ml, graduated	1
CLS-4217-03	Anaerobic media bottle, 250 ml, graduated	1
CLS-4217-04	Anaerobic media bottle, 500 ml, graduated	1
CLS-4217-05	Anaerobic media bottle, 1.000 ml, graduated	1
Replacement components		
CLS-4209-12	Aluminum seals only, 20 mm diameter	100
CLS-4209-14	Blue butyl rubber stoppers only	100

Crimper and Decapper for Anaerobic Culture Tubes and Bottles



- Hand operated
- For 20 mm aluminum seals (CLS-4209-12, page 24)

Cat. No.	Description	Cs.
CG-4930-20	Crimper for 20 mm aluminum seals	1
CG-4930-21	Decapper (Pliers-Type)	1
CV-5706-0020	Decapper for 20 mm aluminum seals (Crimp-Type)	1

Anaerobic Stopper for GL45 Flasks



- Anaerobic stopper optimized to fit GL45 bottles
- High purity bromobutyl rubber with low permeability to air, gases and moisture
- Upper surface features seven numbered impressions for repeated needle piercing
- Temperature range: -50 to +121 °C

Cat. No.	Description	Cs.
CLS-4209-B45	Anaerobic Stopper, 45 mm	10
CLS-1481-21	Cap, GL-45, blue, open top, polypropylene	6

Centrifuge Tubes, Glass

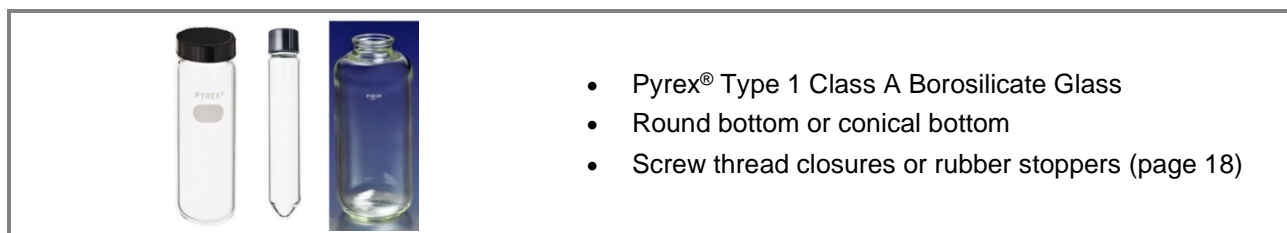

- Pyrex® Type 1 Class A Borosilicate Glass
- Round bottom or conical bottom
- Screw thread closures or rubber stoppers (page 18)

Cat. No.	Description	Cs.
CG-8840-50	50 ml centrifuge tubes, Pyrex® glass, black phenolic and rubber lined screw cap, 24-410 GPI thread, round bottom, 29 x 122 mm (OD x Length)	12
CG-8840-100	100 ml centrifuge tube, Pyrex® glass, black PP and PTFE lined screw cap, 38-400 GPI thread, round bottom, 43 x 139 mm (OD x Length)	1
CG-4013-01	50 ml centrifuge tube, black phenolic PP lined screw cap, 24-415 GPI thread, conical bottom, 28 x 155 mm (OD x Length)	1
CG-8066-250	250 ml centrifuge bottles, Pyrex® glass, heavy wall, for rubber stoppers # 6	12
CG-8066-500	500 ml centrifuge bottles, Pyrex® glass, heavy wall, for rubber stoppers # 6	6

Centrifuge Tubes, Black, Polypropylene

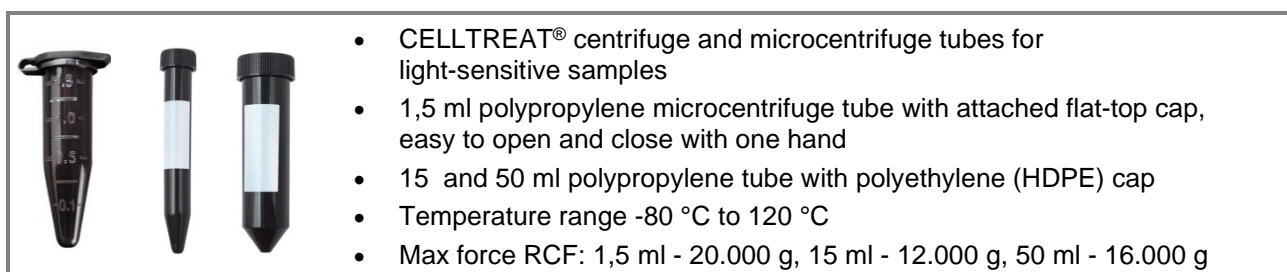

- CELLTREAT® centrifuge and microcentrifuge tubes for light-sensitive samples
- 1,5 ml polypropylene microcentrifuge tube with attached flat-top cap, easy to open and close with one hand
- 15 and 50 ml polypropylene tube with polyethylene (HDPE) cap
- Temperature range -80 °C to 120 °C
- Max force RCF: 1,5 ml - 20.000 g, 15 ml - 12.000 g, 50 ml - 16.000 g

Cat. No.	Capacity	Description	Cs.
CLS-4310-B15	1,5 ml	PP microcentrifuge tubes, black, inner package 500 pieces	1.000
CLS-4303-B14	15 ml	PP centrifuge tubes, black, inner package 25 pieces	100
CLS-4303-B15	15 ml	PP centrifuge tubes, black, inner package 25 pieces	500
CLS-4303-B49	50 ml	PP centrifuge tubes, black, inner package 25 pieces	100
CLS-4303-B50	50 ml	PP centrifuge tubes, black, inner package 25 pieces	500

Hybridization Bottles

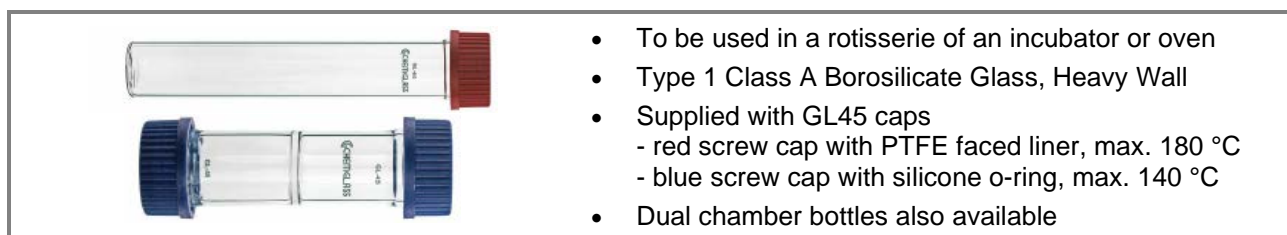

- To be used in a rotisserie of an incubator or oven
- Type 1 Class A Borosilicate Glass, Heavy Wall
- Supplied with GL45 caps
 - red screw cap with PTFE faced liner, max. 180 °C
 - blue screw cap with silicone o-ring, max. 140 °C
- Dual chamber bottles also available

Cat. No.	Bottle ID x Length (mm), cap style	Cs.
CG-1140-01	35 x 75 mm, red cap	1
CG-1140-02	35 x 100 mm, red cap	1
CG-1140-03	35 x 150 mm, red cap	1
CG-1140-04	35 x 250 mm, red cap	1
CG-1140-05	35 x 300 mm, red cap	1
CG-1140-07	35 x 150 mm, dual chamber, red cap	1
CG-1140-08	35 x 300 mm, dual chamber, red cap	1
CG-1140-10	35 x 75 mm, blue cap	1
CG-1140-11	35 x 100 mm, blue cap	1
CG-1140-12	35 x 150 mm, blue cap	1
CG-1140-13	35 x 250 mm, blue cap	1
CG-1140-14	35 x 300 mm, blue cap	1
CG-1140-16	35 x 150 mm, dual chamber, blue cap	1
CG-1140-17	35 x 300 mm, dual chamber, blue cap	1

Cover Slips

Round Cover Slips



- Manufactured from highest quality Borosilicate Glass
- High chemical resistance
- Ideal for neuronal tissue cultures and less adherent cells
- Exceptional for fluorescence and confocal microscopy
- Glass thickness #1: 0,13 - 0,16 mm
- Packing unit: one ounce / approx. 28 g

Cat. No.	Size	Glass	Thickness	Approx. pc./Cs.
CLS-1760-012	12 mm Ø	"German Glass"	# 1	650
CLS-1760-015	15 mm Ø	"German Glass"	# 1	378
CLS-1760-025	25 mm Ø	"German Glass"	# 1	160
CLS-1763-012	12 mm Ø	Corning 0211 Float Glass	# 1	650
CLS-1763-015	15 mm Ø	Corning 0211 Float Glass	# 1	378
CLS-1763-018	18 mm Ø	Corning 0211 Float Glass	# 1	170
CLS-1763-025	25 mm Ø	Corning 0211 Float Glass	# 1	160

Rectangular and Square Cover Slips



- Manufactured from highest quality Borosilicate Glass
- Glass thickness:
 - # 1: 0,13 - 0,16 mm
 - # 1,5: 0,16 - 0,19 mm
 - # 2: 0,17 - 0,25 mm
- Packing unit: one ounce / approx. 28 g

Cat. No.	Size	Glass	Thickness	Approx. pc./Cs.
CLS-1762-1818	18 x 18 mm	White Glass	# 1	242
CLS-1762-2222	22 x 22 mm	White Glass	# 1	150
CLS-1762-2525	25 x 25 mm	Corning 0211 Float Glass	# 1	125
CLS-1762-0935	9 x 35 mm	Corning 0211 Float Glass	# 1	260
CLS-1762-0950	9 x 50 mm	Corning 0211 Float Glass	# 1	175
CLS-1762-1050	10,5 x 50 mm	Corning 0211 Float Glass	# 1	150
CLS-1762-1354	13 x 54 mm	White Glass	# 1	120
CLS-1762-2230	22 x 30 mm	Corning 0211 Float Glass	# 1	119
CLS-1762-2240	22 x 40 mm	White Glass	# 1	89
CLS-1762-2250	22 x 50 mm	White Glass	# 1	71
CLS-1762-2430	24 x 30 mm	White Glass	# 1	109
CLS-1762-2440	24 x 40 mm	White Glass	# 1	82
CLS-1762-2450	24 x 50 mm	White Glass	# 1	65
CLS-1762-2460	24 x 60 mm	Corning 0211 Float Glass	# 1	54
CLS-1762-2575	25 x 75 mm	Corning 0211 Float Glass	# 1	40
CLS-1764-1818	18 x 18 mm	White Glass	# 1,5	209
CLS-1764-2222	22 x 22 mm	Corning 0211 Float Glass	# 1,5	140
CLS-1764-2230	22 x 30 mm	Corning 0211 Float Glass	# 1,5	103
CLS-1764-2240	22 x 40 mm	White Glass	# 1,5	77
CLS-1764-2250	22 x 50 mm	Corning 0211 Float Glass	# 1,5	62
CLS-1764-2430	24 x 30 mm	Corning 0211 Float Glass	# 1,5	94
CLS-1764-2440	24 x 40 mm	White Glass	# 1,5	71
CLS-1764-2450	24 x 50 mm	Corning 0211 Float Glass	# 1,5	56
CLS-1765-1818	18 x 18 mm	Corning 0211 Float Glass	# 2	179
CLS-1765-2222	22 x 22 mm	Corning 0211 Float Glass	# 2	120
CLS-1765-2525	25 x 25 mm	Corning 0211 Float Glass	# 2	93

Tissue Grinders, Homogenizers

Tissue Grinder, Dounce



- Designed for studies where the nucleus has to remain intact
- Polished mortar and pestles
- All glass construction
- Supplied with two pestles:
 - Pestle A: large clearance, for initial sample reduction
 - Pestle B: small clearance, to form the final homogenate

Cat. No.	Working capacity	Pestle diameter, chamber length	Cs.
CLS-5003-01	1 ml	11 mm, 48 mm	1
CLS-5003-02	7 ml	13 mm, 82 mm	1
CLS-5003-03	15 ml	22 mm, 94 mm	1
CLS-5003-04	40 ml	32 mm, 140 mm	1

Tissue Grinder, Potter-Elvehjem



- Round unground glass pestle and polished mortar
- Generally used with soft tissue such as brain and liver

Cat. No.	Working capacity	Pestle diameter, chamber length	Cs.
CLS-5004-01	0,1 ml	3,65 mm, 31 mm	1
CLS-5004-02	1 ml	5,00 mm, 55 mm	1
CLS-5004-03	3 ml	9,00 mm, 60 mm	1
CLS-5004-04	5 ml	10,0 mm, 65 mm	1
CLS-5004-05	10 ml	13,0 mm, 75 mm	1
CLS-5004-06	15 ml	15,0 mm, 80 mm	1
CLS-5004-07	30 ml	19,0 mm, 105 mm	1
CLS-5004-08	55 ml	25,0 mm, 125 mm	1

Tissue Grinder, Potter-Elvehjem, PTFE-Pestle



- PTFE-pestle and unground mortar
- Stainless steel shaft, suitable for Overhead Drive (see page 29)
- Optional "T" handle to assist manual grinding
- Radial serrations in the lower portion of the pestle facilitate the delivery of homogenate into the cylindrical portion of the mortar

Cat. No.	Working capacity	Pestle diameter, chamber length	Cs.
CLS-5005-01	5 ml	10 mm, 65 mm	1
CLS-5005-02	10 ml	13 mm, 75 mm	1
CLS-5005-03	15 ml	15 mm, 80 mm	1
CLS-5005-04	30 ml	19 mm, 105 mm	1
CLS-5005-05	55 ml	25 mm, 125 mm	1
CLS-5005-20	Optional "T" handle stainless steel		1

Tissue Grinder, Tenbroeck

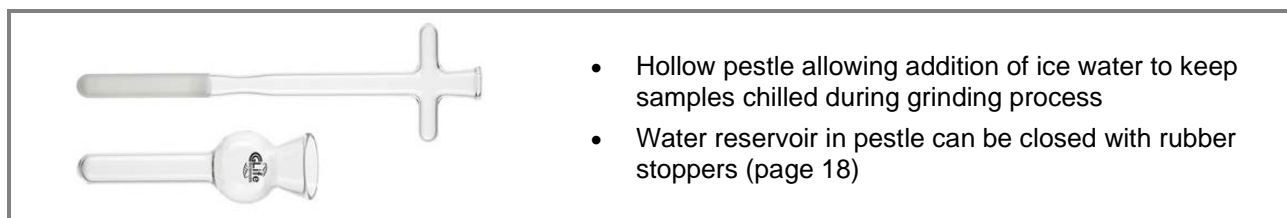

- Hollow pestle allowing addition of ice water to keep samples chilled during grinding process
- Water reservoir in pestle can be closed with rubber stoppers (page 18)

Cat. No.	Working capacity	Pestle Ø, chamber length, stopper size	Cs.
CLS-5006-01	5 ml	10 mm, 65 mm, 000	1
CLS-5006-02	10 ml	13 mm, 75 mm, 00	1
CLS-5006-03	15 ml	15 mm, 80 mm, 0	1
CLS-5006-04	30 ml	19 mm, 105 mm, 2	1
CLS-5006-05	55 ml	25 mm, 125 mm, 4	1

Tissue Grinder, Tapered, all glass

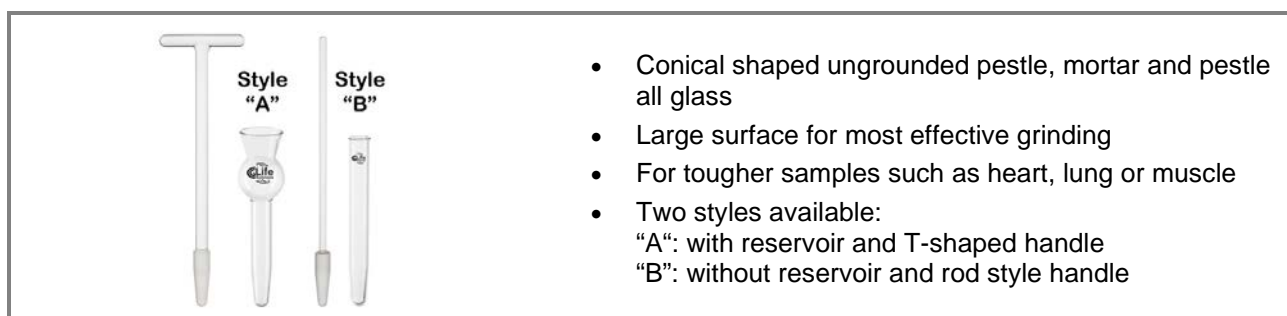

- Conical shaped ungrounded pestle, mortar and pestle all glass
- Large surface for most effective grinding
- For tougher samples such as heart, lung or muscle
- Two styles available:
"A": with reservoir and T-shaped handle
"B": without reservoir and rod style handle

Cat. No.	Working capacity	Style	Cs.
CLS-5007-01	15 ml	"A"	1
CLS-5007-02	15 ml	"B"	1

Tissue Grinder, Griffiths, all glass

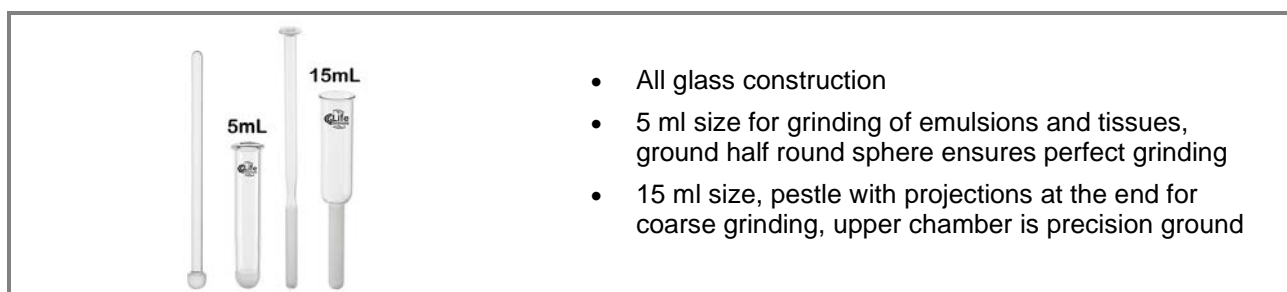

- All glass construction
- 5 ml size for grinding of emulsions and tissues, ground half round sphere ensures perfect grinding
- 15 ml size, pestle with projections at the end for coarse grinding, upper chamber is precision ground

Cat. No.	Working capacity	Pestle diameter, chamber length	Cs.
CLS-5008-01	5 ml	12 mm, 80 mm	1
CLS-5008-02	15 ml	15 mm, 95 mm	1

Tissue Grinder, Micro Overhead Stirrer

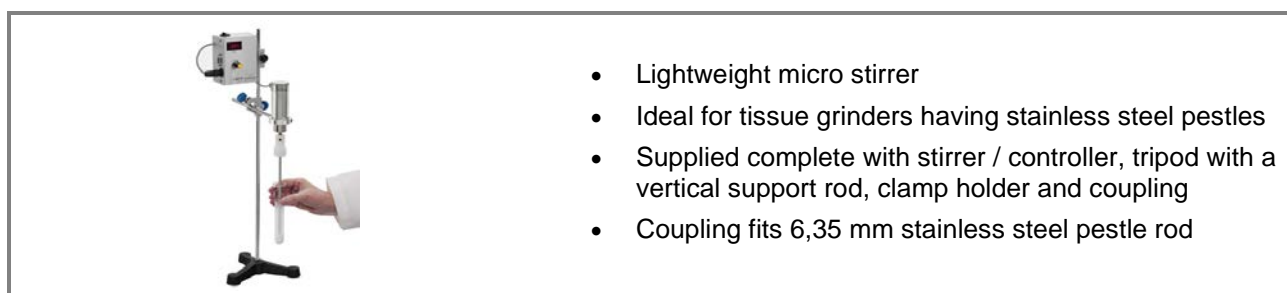

- Lightweight micro stirrer
- Ideal for tissue grinders having stainless steel pestles
- Supplied complete with stirrer / controller, tripod with a vertical support rod, clamp holder and coupling
- Coupling fits 6,35 mm stainless steel pestle rod

Cat. No.	Description	Cs.
CG-2039-A-500	Micro Overhead stirrer for tissue grinders, complete	1

⇒ For more overhead stirrers see page 11

Tissue Grinders, Closed Systems, Sterile



- Tissue Grinders with a patented closed system design provide the ability to grind the specimen in a sealed container helping to prevent any risk of contact with the sample
- Ultra tissue grinders have vitrified pestle tips resulting in a glass-like abrasive surface, which provides a more aggressive grinding action to enable efficient processing of difficult and fibrous samples
- Sterilized by gamma irradiation
- Supplied in an easy-to-open package with an extra cap for storage and transport plus a patient identification label for traceability

Cat. No.	Description	Cs.
CLS-5015	Tissue grinder, 15 ml, conical	10
CLS-5035	Tissue grinder, 35 ml, free standing	10
CLS-5050	Tissue grinder, 50 ml, conical	10
CLS-5115	Ultra tissue grinder, 15 ml, conical	10
CLS-5150	Ultra tissue grinder, 50 ml, conical	10

BioVortexer, Motor, Disposable Pestles and Tubes



- To drive PP pestles in 0,5 ml and 1,5 ml tubes
- Battery-powered, two AA batteries included
- Pestles and tubes manufactured from PP, DNase-, RNase- and Pyrogen-free
- Sterile, autoclavable
- Centrifugal pellets, precipitates and other solids are completely dispersed in seconds

Cat. No.	Description	Cs.
CLS-5001-001	BioVortexer Mixer only	1
CLS-5002-021	Pestle, for 0,5 ml tubes, individually wrapped	100
CLS-5002-023	Tubes, 0,5 ml, PP, individually wrapped	100
CLS-5002-025	Pestle and Tubes, 0,5 ml, individually wrapped	100
CLS-5002-031	Pestle, for 1,5 ml Tubes, individually wrapped	100
CLS-5002-033	Tubes, 1,5 ml, PP, individually wrapped	100
CLS-5002-035	Pestle and Tubes, 1,5 ml, individually wrapped	100
CLS-5002-B21	Pestle, for 0,5 ml Tubes, bulk packed	100
CLS-5002-B23	Tubes, 0,5 ml, PP, bulk packed	100
CLS-5002-B25	Pestle and Tubes, 0,5 ml, bulk packed	100
CLS-5002-B31	Pestle, for 1,5 ml Tubes, bulk packed	100
CLS-5002-B33	Tubes, 1,5 ml, PP, bulk packed	100
CLS-5002-B35	Pestle and Tubes, 1,5 ml, bulk packed	100

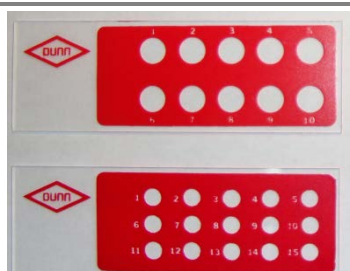

Multispot Microscope Slides

for Immunofluorescence Tests
and Cell Culture.

Information on request!

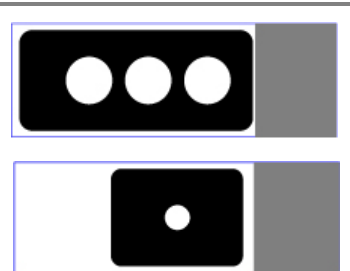

Tissue Grinder, Stainless Steel, Cell Dissociation Sieves

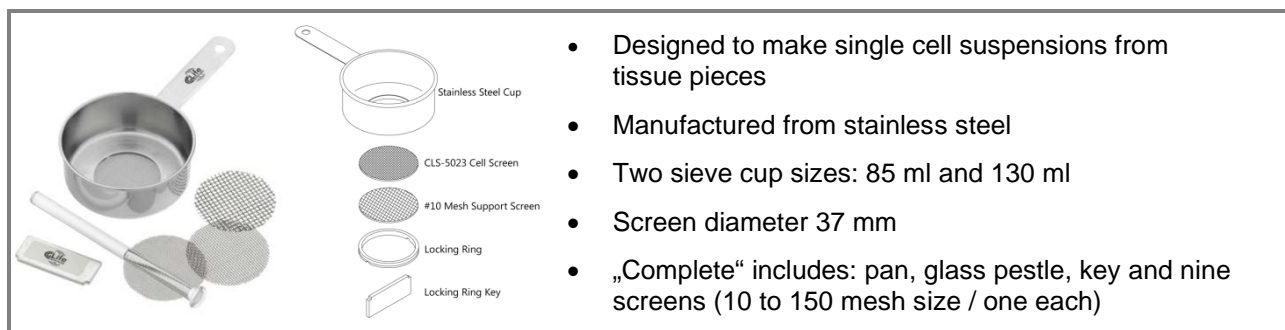

- Designed to make single cell suspensions from tissue pieces
- Manufactured from stainless steel
- Two sieve cup sizes: 85 ml and 130 ml
- Screen diameter 37 mm
- „Complete“ includes: pan, glass pestle, key and nine screens (10 to 150 mesh size / one each)

Cat. No.	Description	Cs.
CLS-5020-085	Tissue Grinder, dissociation sieve, complete, 85 mm	1
CLS-5023-010	Cell/Screen (SS), 10 mesh, Ø 2000 µm	5
CLS-5023-020	Cell/Screen (SS), 20 mesh, Ø 841 µm	5
CLS-5023-030	Cell/Screen (SS), 30 mesh, Ø 595 µm	5
CLS-5023-040	Cell/Screen (SS), 40 mesh, Ø 420 µm	5
CLS-5023-050	Cell/Screen (SS), 50 mesh, Ø 297 µm	5
CLS-5023-060	Cell/Screen (SS), 60 mesh, Ø 250 µm	5
CLS-5023-080	Cell/Screen (SS), 80 mesh, Ø 177 µm	5
CLS-5023-100	Cell/Screen (SS), 100 mesh, Ø 149 µm	5
CLS-5023-150	Cell/Screen (SS), 150 mesh, Ø approx. 100 µm	5
CLS-5023-200	Cell/Screen (SS), 200 mesh, Ø 74 µm	5
CLS-5023-300	Cell/Screen (SS), 300 mesh, Ø approx. 50 µm	5
CLS-5023-400	Cell/Screen (SS), 400 mesh, Ø 37 µm	5
CLS-5023-500	Cell/Screen (SS), 500 mesh, Ø approx. 30 µm	5
CLS-5022-016	Glass pestle only, 16 mm	1
CLS-5021-085	Cell pan & locking ring key only, 85 mm	1

Lab Armor Beads™: Water, Ice and Oil Replacement

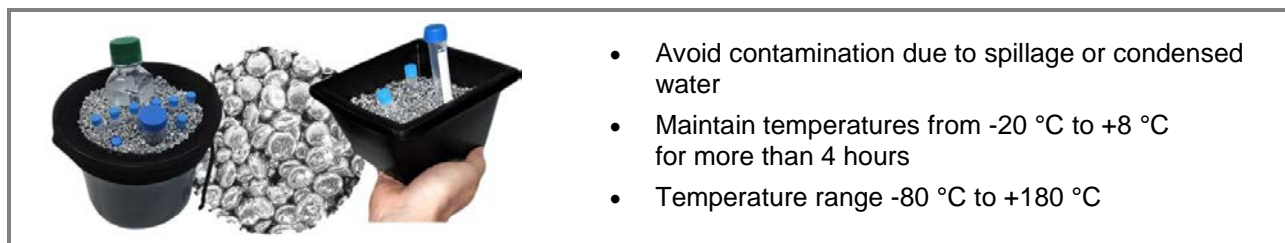

- Avoid contamination due to spillage or condensed water
- Maintain temperatures from -20 °C to +8 °C for more than 4 hours
- Temperature range -80 °C to +180 °C

Cat. No.	Description
Lab Armor Beads™:	H x Ø: 1-2 x 5-8 mm, non-permeable for humidity and gases, non-toxic, non-volatile, high thermal conductivity
42370-002	Lab Armor™ Beads (1 x 2 l)
42370-004	Lab Armor™ Beads (1 x 4 l)
42370-008	Lab Armor™ Beads (2 x 4 l)

Trays and Buckets:

39438-002	Walkabout™ - PVC Tray without Beads, W x D x H: 15,2 x 15,2 x 7,6 cm, for temperatures from -196 °C to 93 °C
39438-001	Walkabout™ - PVC Tray Walkabout™ with 1 l Beads
67200-005	Chill Bucket™, Polyurethane Bucket, H x Ø: 17,8 x 26,7 cm (without handles), for temperatures from -193 °C to 100 °C, Bead Bag and 2 Chill Packs, without Beads
67200-001	Chill Bucket™, Polyurethane Bucket, Bead Bag, 2 Chill Packs and 2 l Beads
39956-050	StayTemp™ - Stainless Steel Tray (1 l) with 1,25 l Beads
39956-001	StayTemp™ - Stainless Steel Tray (2 l) with 2 l Beads
39956-003	StayTemp™ - Stainless Steel Tray (4 l) with 4 l Beads

Lab Armor® Bead Bath™ available with different capacities.

For prices and more Lab Armor® products please enquire.

Magnetic Stirrers

The **Dura-Mag™ series** of digital magnetic stirrer is designed for both cell culture in spinner flasks as well as general laboratory procedures requiring the use of magnetic stirring equipment. Dura-Mag™ stirrers feature brushless, maintenance-free DC motors with drive assemblies designed for quiet operation. Stainless steel covers are stamped to show the vessel positions for accurate placement and optimum performance. Dura-Mag™ stirrers can be used at temperatures between 0 °C and 40 °C, for example in CO₂ incubators.

Dura-Mag™ 5-Position Magnetic Stirrer

- Speed range: 25 - 400 rpm
- Dimension: approx. 42,5 x 48,9 x 8,9 cm
- Maximum flask sizes:
Standard: 5 x 1 litre or 4 x 3 litre



Cat. No.	Description
CLS-4100-06E	5-Position magnetic stirrer, <u>standard</u>
CLS-4100-A6E	5-Position magnetic stirrer, <u>standard</u> , with factory installed alarm

Dura-Mag™ 9-Position Magnetic Stirrer

- Speed range: 25 - 400 rpm
- Dimension: approx. 42,5 x 48,9 x 8,9 cm
- Maximum flask size: 9 x 500 ml



Cat. No.	Description
CLS-4100-09E	9-Position magnetic stirrer
CLS-4100-A9E	9-Position magnetic stirrer with factory installed alarm

6- and 15-Position Magnetic Stirrers with On-Board Timer

- Speed range: 80 - 1.500 rpm
- 6-Position magnetic stirrer
 - Dimension: approx. 23,0 x 5,2 x 37,0 cm
 - Maximum flask size: 6 x 400 ml
- 15-Position magnetic stirrer
 - Dimension: approx. 23,0 x 5,2 x 37,0 cm
 - Maximum flask size: 15 x 250 ml
- Timer for unattended operation: 1-900 min
- Adjustable reverse operation: 5-900 sec
- Speed Servo™ ensures constant speed even when the viscosity changes
- Chemical resistant stainless steel top plate



Cat. No.	Description
CG-1998-V06E	6-Position magnetic stirrer
CG-1998-V15E	15-Position magnetic stirrer

Also available: 2-Position and 5-Position Compact Magnetic Stirrers for large and for small Spinner Flasks. Please enquire.

Reaction Blocks to be used with Stirring Hotplates

Digital Stirring Hotplate



- Fast, precise temperature control from 0 to 370 °C
- Accurate stirring from 30 to 1.700 rpm
- Integral timer, 1 minute to 99 hours, 59 minutes, automatically turns heater off after the elapsed time
- Auto-reverse option for enhanced mixing
- Maintains set rpm even with viscosity changes
- Chemical- and scratch-resistant, ceramic-coated top, CerAITop™, 135 mm diameter, aluminum alloy plate
- Bright white LED display for high-contrast easy reading
- Illuminated icons for heat, probe, setpoint, timer and autoreverse

Cat. No.	Description	Cs.
CG-1997-V-50E	Complete Digital Hotplate Kit with Temperature Probe, Vertical Support Rod, Boss Head and Support / Holding Rod	1
CG-1997-V-10E	Digital Hotplate with Temperature Probe only	1

One Size Reaction Blocks for Vials



- Designed to fit directly on 135 mm dia. circular top of a hotplate stirrer
- Aluminum construction offers excellent heat transfer without interfering with magnetic stirring
- Anodized for increased strength, durability and chemical resistance
- A thermowell is provided for insertion of a temperature sensor

Cat. No.	Description	Cs.
CG-1991-01	Reaction Block for 20 ml scintillation vials, 28 mm x 60 mm, black, 17 positions, 24 mm hole depth	1
CG-1991-02	Reaction Block for 30 ml scintillation vials, 28 mm x 73 mm, green, 17 positions, 30 mm hole depth	1
CG-1991-03	Reaction Block for 40 ml scintillation vials, 28 mm x 98 mm, orange, 17 positions, 43 mm hole depth	1
CG-1991-04	Reaction Block for 4 ml vials, 15 mm x 45 mm, gold, 48 positions, 19 mm hole depth	1
CG-1991-05	Reaction Block for 8 ml vials, 17 mm x 60 mm, blue, 34 positions, 25 mm hole depth	1
CG-1991-06	Reaction Block for 16 ml vials, 21 mm x 70 mm, red, 21 positions, 32 mm hole depth	1

TRI-Block™, Reaction Block for Vials



- Designed to fit directly on 135 mm dia. circular top of a hotplate stirrer
- Aluminum construction offers excellent heat transfer without interfering with magnetic stirring
- Anodized for increased strength, durability and chemical resistance
- A thermowell is provided for insertion of a temperature sensor

Cat. No.	Description	Cs.
CG-1991-T-10	Tri-Block™ Reaction Block, 11 positions each for 4 ml and 8 ml vials, 7 positions for 20 ml vials	1

PIE-Blocks, Reaction Blocks for Vials and Flasks



- Designed to fit directly on 135 mm diameter circular top of a hotplate stirrer
- Safety holder allows up to four pie wedges on one hotplate and securely locks them together
- Interchangeable pie wedges and blocks permit various sized vials and flasks on one hotplate
- Aluminum construction offers excellent heat transfer without interfering with magnetic stirring
- Anodized for increased strength, durability and chemical resistance
- Colour coded for quick and easy identification
- A thermowell is provided for insertion of a temperature sensor

Cat. No.	Description	Included in CG-1991-P-01	Cs.
CG-1991-P-01	PIE-Block system, supplied with one safety holder and six pie wedges (including CG-1991-P-05, -P-10 to -P-15)		1
CG-1991-P-05	PIE-Block safety holder only, anodized green	Yes	1
CG-1991-P-10	Pie-Wedge for 20 ml scintillation vials, 28 mm x 60 mm, anodized black, 4 positions, 24 mm hole depth	Yes	1
CG-1991-P-11	Pie-Wedge for 30 ml scintillation vials, 28 mm x 73 mm, anodized green, 4 positions, 30 mm hole depth	Yes	1
CG-1991-P-12	Pie-Wedge for 40 ml scintillation vials, 28 mm x 98 mm, anodized orange, 4 positions, 43 mm hole depth	Yes	1
CG-1991-P-13	Pie-Wedge for 4 ml vials, 15 mm x 45 mm, anodized gold, 9 positions, 19 mm hole depth	Yes	1
CG-1991-P-14	Pie-Wedge for 8 ml vials, 17 mm x 60 mm, anodized blue, 8 positions, 25 mm hole depth	Yes	1
CG-1991-P-15	Pie-Wedge for 16 ml vials, 21 mm x 70 mm, anodized red, 4 positions, 32 mm hole depth	Yes	1
CG-1991-P-19	Pie-Wedge for 2 - 5 ml microwave vials, anodized turquoise, 8 positions	No	1
CG-1991-P-20	Pie-Wedge for 10 - 20 ml microwave vials, anodized berry, 4 positions	No	1
CG-1991-P-23	Pie-Wedge for 0,5 - 2 ml tapered microwave vials, anodized purple, 8 positions	No	1
CG-1991-P-30	Pie-Block for one 10 ml round bottom flask, anodized gold	No	1
CG-1991-P-32	Pie-Block for one 25 ml round bottom flask, anodized blue	No	1
CG-1991-P-34	Pie-Block for one 50 ml round bottom flask, anodized red	No	1
CG-1991-P-36	Pie-Block for one 100 ml round bottom flask, anodized black	No	1

Reaction Blocks for NMR Tubes



- NMR Reaction Heating Block is designed to rest on a round or square top of a hotplate stirrer
- Offers a clean and safe alternative to heating NMR tubes in oil baths
- Aluminum construction offers excellent heat transfer

Cat. No.	Description	Cs.
CG-1991-N-10	Reaction Heating Block for 5 mm NMR tubes, anodized clear, 10 positions	1

OPTITHERM® Reaction Blocks for Round Bottom and Recovery Flasks



- Designed to fit directly on 135 mm diameter circular top of a hotplate stirrer
- A safe and cost effective solution for replacing your existing oil bath and heating mantles
- PTFE shield on the unit reduces the exterior exposed surface temperature by as much as 100 °C
- Aluminum construction offers excellent heat transfer without interfering with magnetic stirring
- Anodized inserts for increased strength, durability and chemical resistance
- Colour-coded inserts for quick and easy identification
- Flask inserts must be purchased separately

Cat. No.	Description	For use with	Cs.
CG-1992-10	OPT100 Reaction Block, for 100 ml round bottom flasks or with inserts below		1
CG-1992-50	OPT500 Reaction Block, for 500 ml round bottom flasks or with inserts below		1
CG-1992-60	OPT1000 Reaction Block, for 1000 ml round bottom flasks or with inserts below		1
CG-1992-12	10 ml round bottom flask insert, anodized gold	OPT100	1
CG-1992-14	25 ml round bottom flask insert, anodized blue	OPT100	1
CG-1992-16	50 ml round bottom flask insert, anodized red	OPT100	1
CG-1992-53	200 ml round bottom flask insert, anodized turquoise	OPT500	1
CG-1992-54	250 ml round bottom flask insert, anodized clear	OPT500	1
CG-1992-55	300 ml round bottom flask insert, anodized black	OPT500	1
CG-1992-58	500 ml round bottom flask insert, anodized berry	OPT1000	1
CG-1992-R010	10 ml recovery flask insert, anodized orange	OPT100	1
CG-1992-R025	25 ml recovery flask insert, anodized green	OPT100	1
CG-1992-R050	50 ml recovery flask insert, anodized blue	OPT100	1
CG-1992-R100	100 ml recovery flask insert, anodized yellow	OPT500	1
CG-1992-R200	200 ml recovery flask insert, anodized red	OPT500	1
CG-1992-R500	500 ml recovery flask insert, anodized berry	OPT1000	1

OptiBlock Reaction Blocks for Parallel Synthesis



- Designed to fit directly on 135 mm diameter circular top of a hotplate stirrer
- Accepts up to eight different vial sizes
- PTFE faced silicone septa pad seals multiple vessels effectively
- Provides syringe access to all vessels
- Withstands aggressive solvents

Cat. No.	Description	Cs.
OP-5000-01	OptiBlock Reaction Block, locking base assembly only	1
OP-5000-09	OptiBlock Reaction Block, top locking plate, 8 x 30 mm, 96-well, green	1
OP-5000-10	OptiBlock Reaction Block, top locking plate, 15 x 45 mm, 4 ml vial, purple	1
OP-5000-12	OptiBlock Reaction Block, top locking plate, 17 x 60 mm, 8 ml vial, gold	1
OP-5000-14	OptiBlock Reaction Block, top locking plate, 21 x 70 mm, 16 ml vial, red	1
OP-5000-16	OptiBlock Reaction Block, top locking plate, 28 x 57 mm, 20 ml vial, blue	1
OP-5000-17	OptiBlock Reaction Block, top locking plate, 28 x 70 mm, 30 ml vial, silver	1
OP-5000-18	OptiBlock Reaction Block, top locking plate, 28 x 95 mm, 40 ml vial, orange	1
OP-5000-19	OptiBlock Reaction Block, top locking plate, 0,5 - 2 ml tapered and 2 - 5 ml round bottom microwave vial, green	1
OP-5000-20	OptiBlock Reaction Block, top locking plate, 10 - 20 ml microwave vial, turquoise	1
OP-5000-60	OptiBlock Reaction Block, PTFE faced silicone septa pads	10
OP-5000-K1	OptiBlock Reaction Block, start up kit, includes: OP-5000-01, -10, -12, -16 (one of each), OP-6600-05, -07, -11 (one of each), and OP-5000-60 (20 pieces)	1

OPTICHEM® Reaction Blocks for Centrifugal Vacuum Evaporator Blocks

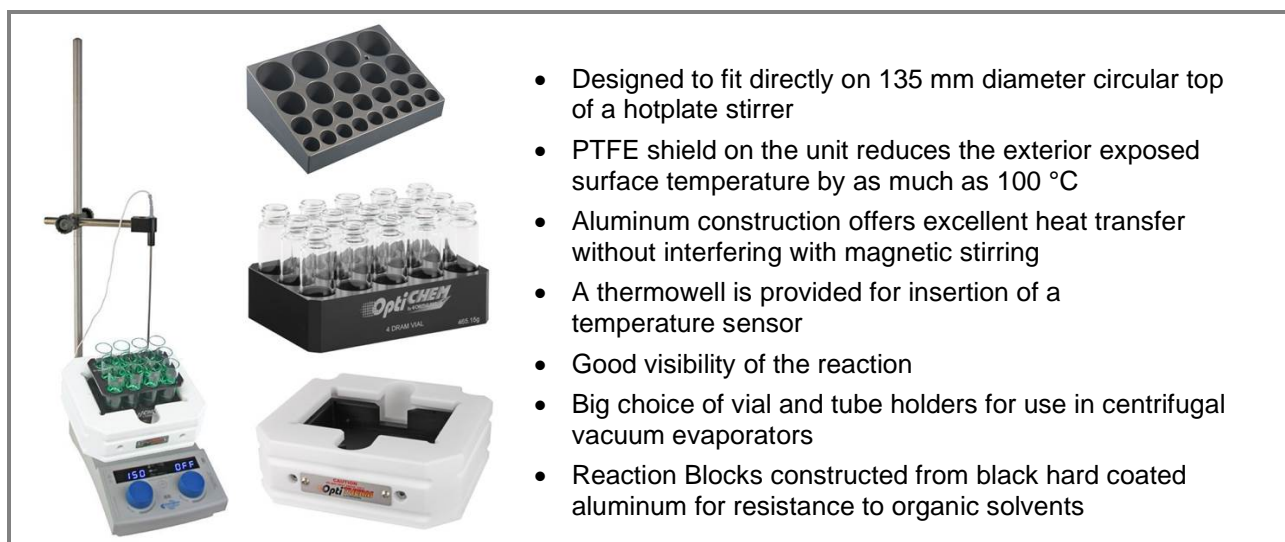

Cat. No.	Description	Cs.
OP-6700-01	Heater Block Adapter	1
OP-6600-04	Reaction Block for 8 x 30 mm Shell vial inserts, 96 positions	1
OP-6600-03	Reaction Block for 12 x 32 mm HPLC flat bottom vials, 48 positions	1
OP-6600-05	Reaction Block for 15 x 45 mm 4 ml flat bottom vials, 24 positions	1
OP-6600-07	Reaction Block for 17 x 60 mm 8 ml flat bottom vials, 24 positions	1
OP-6600-09	Reaction Block for 21 x 70 mm 16 ml flat bottom vials, 15 positions	1
OP-6600-11	Reaction Block for 28 x 57 mm 20 ml scintillation vials and 28 x 70 mm 30 ml scintillation flat bottom vials, 11 positions	1
OP-6600-12	Reaction Block for 28 x 70 mm 40 ml scintillation vials and 28 x 95 mm 60 ml scintillation flat bottom vials, 11 positions, two tier design	1
OP-6600-18	Reaction Block for 14 mm OD haystack sample storage vials, 24 positions	1
OP-6600-20	Reaction Block for 16 x 83 mm 0,5 - 2 ml tapered microwave vials, 24 positions, two tier design	1
OP-6600-21	Reaction Block for 16 x 83 mm 2 - 5 ml round bottom microwave vials, 24 positions, two tier design	1
OP-6600-22	Reaction Block for 28 x 83 mm 10 - 20 ml round bottom microwave vials, 8 positions, two tier design	1
OP-6600-30	Reaction Block for 10 x 75 mm round bottom tubes, 70 positions	1
OP-6600-34	Reaction Block for 12 x 75 mm round bottom tubes, 40 positions	1
OP-6600-36	Reaction Block for 13 x 100 mm round bottom tubes, 24 positions, two tier design	1
OP-6600-38	Reaction Block for 16 x 100 mm round bottom tubes, 24 positions, two tier design	1
OP-6600-40	Reaction Block for 18 x 100 mm round bottom tubes, 24 positions, two tier design	1
OP-6600-42	Reaction Block for 25 x 100 mm round bottom tubes, 12 positions, two tier design	1
OP-6600-90	Multi-Vial Reaction Block, 25 positions 4 positions for 20 - 30 ml vials, 5 positions for 8 ml vials or 2 - 5 ml microwave vials, 7 positions for 4 ml vials, 9 positions for 12 x 32 mm autosampler vials	1

Rockers and Shakers

All rockers and shakers feature a 24V brushless low maintenance DC motor and speed controller, a digital speed display and a locking speed control knob. The bases accept a variety of optional trays fixed with peg and grommet tray connections, making changing of platforms convenient and interchangeable with other similar systems.

Versa-Rock™ Digital Rocker



The **Versa-Rock™** is a digital slow speed rocker for general laboratory cell culture work.

- Speed range: 5 - 30 / min
- Range of motion: 5 - 14 °
- Max. load: 9 kg
- Base dimensions (w x d x h): 30,2 x 31,75 x 14,3 cm

Cat. No.	Description
CLS-4033-100E	Rocker, base only (trays sold separately)

Versa-Orb™ Digital Orbital Shaker, 25,4 mm Orbit



The **Versa-Orb™** is a heavy-duty, variable speed shaker. The device is ideal for the agitation of gels, staining, de-staining and assay development.

- Speed range: 10 - 350 rpm
- Orbit: 25,4 mm / 1 “
- Max. load: 10 kg
- Base dimensions (w x d x h): 30,2 x 30,5 x 11,4 cm

Cat. No.	Description
CLS-4021-100E	Orbital shaker, base only (trays sold separately)

Versa-Shake Digital Reciprocating Shaker



The Versa-Shake reciprocating digital shaker is designed to shake clear plastic cell culture bags with a working volume of up to 10 litres and for general laboratory purposes.

- Speed range: 20 - 240 oscillations / min
- Stroke: 25,4 mm / 1 “
- Max. load: 16 kg evenly distributed
- Base dimensions (w x d x h): 30,2 x 30,5 x 11,4 cm

Cat. No.	Description
CLS-4009-100E	Reciprocating shaker, base only (trays sold separately)

Aluminium Trays with Liners, Single or Stackable



- To be used with shaker and rocker bases

Cat. No.	Description
CLS-4021-1212	Aluminum tray, 305 x 305 mm
CLS-4021-1515	Aluminum tray, 381 x 381 mm
CLS-4021-2020	Aluminum tray, 508 x 508 mm
CLS-4021-2030	Aluminum tray, 508 x 762 mm
CLS-4021-0001	Stackable tray kit for CLS-4021-1212, 305 x 305 mm
CLS-4021-0003	Stackable tray kit for CLS-4021-1515, 381 x 381 mm
CLS-4021-0005	Stackable tray kit for CLS-4021-2020, 508 x 508 mm

Tilting Rack for Shaker Base



- 49 positions for 50 ml tubes (skirted or standard)
- Angle adjustment of up to 30°
- Silicone gasket holds tube securely
- The rack is supplied with four attached pegs which fit directly into the top of our orbital shaker CLS-4021-100E. Rack can also be used with other orbital shakers by using of double faced sticky tape

Cat. No.	Description
CLS-4285-R1	Tilting rack, 49 positions, for 50 ml tubes

Sticky Pad



- Ideal for bottles and dishes with flat wide bases that cannot be held by traditional flask clamps
- Usable at -30 °C to 70 °C
- Reuseable by washing with mild detergent and water
- Maximal shaking speed (fill volume 25 %):

Flask size	Max. speed
25 - 500 ml	200 rpm
1000 - 2000 ml	250 rpm
3000 ml	300 rpm
4000 - 6000 ml	250 rpm

Cat. No.	Description	Cs.
CLS-4010-16	Sticky pad, 400 x 500 mm	1

Double-sided Sticky Tape

Cat. No.	Description	Cs.
CLS-4008-T03	Double-sided sticky tape, 150 cm, for single use	1

Bags, Cell Culture, Ultra Clear, 6-Port, to be used with Rocking Platforms



- Material:
 - inner: LDPE (low density polyethylene)
 - outer: ultra clear Flex 600
- Sterile (gamma irradiated)
- Excellent choice for mammalian and plant cell lines with extended mixing times
- USP Class VI tested materials

Cat. No.	Capacity	Working volume	Solution Contact Material	Cs.
CLS-1207-10M	10 l	5 l	PE	10
CLS-1207-20M	20 l	10 l	PE	10
CLS-1207-22M	22 l	11 l	PE	10
CLS-1207-50M	50 l	25 l	PE	10

Roller Bottles, Graduated, TC-Treated, Polystyrene (PS)



- Roller bottles (CELLTREAT®) made from Polystyrene
- Vacuum gas plasma tissue culture treated (untreated roller bottles on request)
- Hydrophilic surface for cell attachment
- Black printed graduations
- Sterile, individually bagged
- Screw cap either solid or vented
- Expanded Surface Area Roller Bottles (ESRB) with ribbed interior

Cat. No.	Description	Ø x Length	Surface Area	Cs.
CLS-1189-S01	Roller bottle, TC-treated, solid cap	116 x 177 mm	490 cm ²	24
CLS-1189-V01	Roller bottle, TC-treated, vented cap	116 x 177 mm	490 cm ²	24
CLS-1188-S01	Roller bottle, TC-treated, solid cap	116 x 274 mm	850 cm ²	12
CLS-1188-V01	Roller bottle, TC-treated, vented cap	116 x 274 mm	850 cm ²	12
CLS-1188-ES1	Roller bottle, TC-treated, ESRB, solid cap	116 x 274 mm	1.900 cm ²	12
CLS-1188-EV1	Roller bottle, TC-treated, ESRB, vented cap	116 x 274 mm	1.900 cm ²	12

Cat. No.	Description	Volume	Cs.
CLS-1188-N01	Roller bottle, non-treated, solid cap	1 l	24
CLS-1188-N02	Roller bottle, non-treated, solid cap	2 l	12
CLS-1188-CAP	Vented Cap		24

Also available: glass roller bottles with solid or vented caps. Please enquire.



Benchtop Roller Apparatus

Accepts glass and plastic roller bottles 11 cm to 12 cm outer Ø x 28,5 cm length



For more information please enquire

Large Roller Apparatus and Roll-In Incubators



Large Scale Roller Apparatus (production units) with either fixed frame construction (8-11 decks with up to 86 positions) or Modular Roller Apparatus (Base and 1-8 decks with up to 45 positions).



Features:

- Rollers formulated from a chemical-resistant, non-transferring rubber EDPM
- Heavy-duty DC motor
- All Position Drive to prevent slipping of lightweight bottles
- Frame: coated Aluminum (chemically treated enamel finish)
- Rubber bumpers, front locking castors
- Accommodates standard plastic or glass roller bottles (11 - 12 cm Ø) with a maximum length of 57 cm (roller length: 51 cm)
- Clearance between decks: 13,4 cm
- Rotation speed: 0,1 - 4,0 rpm (modular) or 0,3 -9 rpm (fixed frame), slow speed options available
- Analog or Digital speed display (depending on model) and locking speed control knob

Optional equipment:

- Battery Back-up system: up to 18 hours of continuous rotation operation during power failure (depending on load and rpm)
- Rotation/Power Alarm: audible and visual alarm system
- Slow Speed Kit: rotational speed down to 0,085 rpm

Please enquire for more information

Roll-In and large Incubators with or without CO₂ from ShellLab/Sheldon

The Roll-In and large capacity incubators are especially designed to be used in combination with roller apparatus.



Please enquire for further incubators – also from other manufacturers

Vacuum Manifolds and AIRFREE® Products (excerpt from product line)

→ pls. also see page 45

Chemglass Airfree® glassware has been designed for the convenient manipulation of highly reactive and moisture sensitive compounds using inert gas to exclude air and moisture. It is a very comprehensive line of glassware designed for organometallic and inorganic chemistry. Available are a wide range of Complete Manifold Systems as well as individual components and a large variety of accessories, including adapters, bubblers, reaction flasks, vacuum gauges and pumps (see examples below). **Please enquire for further product information.**

Vacuum Manifold, Inert Gas Line, 5-Ports, Airfree®, Schlenk



Cat. No.	Description
AF-0450-01	5-Ports Vacuum Manifold, Right Handed Trap Assembly, Double Bank
AF-0450-02	5-Ports Vacuum Manifold, Left Handed Trap Assembly, Double Bank

Bubblers, Pressure Release, Lafler, Airfree®, Schlenk



A: Inlet
B: Outlet
C: Main Chamber
D: Check Valve
E: Pressure Release Chamber

Unique design of bubbler allows for fine control of purge gas within an inert gas system such as a manifold. Purge gas enters bubbler through hose connection (A) and exits through connection (B) which is connected to manifold. The large capacity of the main chamber (C) allows for rapid purging with check valve protection of the inert gas source (D). The constriction of the large chamber prevents oil from being drawn back into the system. The small chamber (E) is equipped with a pressure release valve which is adjustable from 2 to 49 PSI (4 PSI is recommended for most vacuum, inert systems). When charging the system to the correct pressure setting, the bubbler in the main chamber will cease to operate and permit any over-pressure to escape through the small chamber (E).

Please note: Chamber (D) and (E) must be filled halfway with mineral oil for proper operation.
 Approx. dimensions are 150 mm width x 300 mm height.
 Hose connections are 11 mm outer diameter at the largest ring.

Cat. No.	Description
AF-0512-01	Bubbler, Pressure Release, Lafler

Reaction flasks, Airfree®, Schlenk



Round bottom single neck flasks have a standard taper outer joint with a Chem-Vac™ Chem-Cap® valve sidearm. Plug may be removed for sampling from flask while a purge of inert gas is maintained through the sidearm

50, 100, 250 ml: 14/20 outer joint; 250, 500, 1.000 ml: 24/40 outer joint
 50, 100, 250 ml: 0 - 4 mm valve; 250, 500, 1.000 ml: 0 - 8 mm valve

A large choice of other reaction flasks, vessels and tubes can be offered.

Cat. No.	Description
AF-0529	Reaction Flasks with Joint Connection and Valve, 50 to 1.000 ml capacity

Rotary Evaporator Adapters

The Rotary Evaporator Adapters from Chemglass Life Sciences are available to connect the vapour tube or a bump trap of a rotary evaporator to threaded sample vials, to microwave vials with flange or to pressure vessels with PTFE bushings.

Adapter for Threaded Sample Vials

Glass adapters are available in three different joint sizes, all having a 20-400 thread at the bottom. A PTFE-lined, polypropylene, double-threaded connector attaches the vial to the adapter. Connectors are available in six different sizes, enabling the collection of your samples in a broad range of vials.



Cat. No.	Description	Unit
Adapter Kit for Threaded Sample Vials, complete:		
One glass adapter with six threaded vial connectors: 13-425, 15-425, 18-425, 20-400, 22-400, 24-400		
CG-1318-40	24/40 Adapter Kit, complete	1 Kit
CG-1318-41	29/26 Adapter Kit, complete	1 Kit
CG-1318-42	29/42 Adapter Kit, complete	1 Kit
Connector Kit for Threaded Sample Vials, only:		
Six threaded vial connectors: 13-425, 15-425, 18-425, 20-400, 22-400, 24-400; no glass adapter		
CG-1318-30	Connector Kit	1 Kit
Single Components for Threaded Sample Vials:		
CG-1318-10	24/40 Glass Adapter	1 pc.
CG-1318-11	29/26 Glass Adapter	1 pc.
CG-1318-12	29/42 Glass Adapter	1 pc.
CG-1318-20	Connector for 13-425 Sample Vials	1 pc.
CG-1318-21	Connector for 15-425 Sample Vials	1 pc.
CG-1318-22	Connector for 18-425 Sample Vials	1 pc.
CG-1318-23	Connector for 20-400 Sample Vials	1 pc.
CG-1318-24	Connector for 22-400 Sample Vials	1 pc.
CG-1318-25	Connector for 24-400 Sample Vials	1 pc.

Adapter for Microwave Vials

Glass adapters are available in two joint sizes. Adapters are connected to a threaded black Acetal compression cap that is slotted to accept the flange fitting of the microwave vials (CG-4920).



Cat. No.	Description	Unit
CG-1318-A-10	24/40 Adapter for Microwave Vials	1 pc.
CG-1318-A-12	29/42 Adapter for Microwave Vials	1 pc.

Adapter for Pressure Vessels

Glass adapter has a 24/40 joint and is supplied with an open top front seal PTFE bushing with Viton o-ring to connect to pressure vessels (CG-1880).



Cat. No.	Description	Unit
CG-1881-01	24/40 Adapter for Pressure Vessel, #15 PTFE Bushing	1 pc.
CG-1881-02	24/40 Adapter for Pressure Vessel, #25 PTFE Bushing	1 pc.

Vial Funnel for Threaded Sample Vials

PTFE vial funnel screws securely onto any standard laboratory vial having a thread for easy, safe and clean transfer of product.



Cat. No.	Description	Unit
CG-1761-20	Funnel Kit with eight Threaded PTFE Funnels: 8-425, 9-425/10-425, 13-425, 15-425, 18-400, 20-400, 22-400, 24-400	1 Kit
CG-1761-01	Vial Funnel, PTFE, for 8-425 Sample Vials	1 pc.
CG-1761-02	Vial Funnel, PTFE, for 9-425 and 10-425 Sample Vials	1 pc.
CG-1761-03	Vial Funnel, PTFE, for 13-425 Sample Vials	1 pc.
CG-1761-04	Vial Funnel, PTFE, for 15-425 Sample Vials	1 pc.
CG-1761-05	Vial Funnel, PTFE, for 18-400 Sample Vials	1 pc.
CG-1761-06	Vial Funnel, PTFE, for 20-400 Sample Vials	1 pc.
CG-1761-07	Vial Funnel, PTFE, for 22-400 Sample Vials	1 pc.
CG-1761-08	Vial Funnel, PTFE, for 24-400 Sample Vials	1 pc.

Sample Vials and Filtration Adapters

Vials from Borosilicate glass type 1 with PTFE lined solid caps.

Also available are vacuum filtration adapters and adapter kits (CG-1049-C-XX) to connect a threaded (24-400) vial to either a filter funnel (1), to a jointed glass adapter (3), to a Luer lock joint (2) (e.g. SPE column/syringe) or to a second vial. Please inquire for an individual offer.

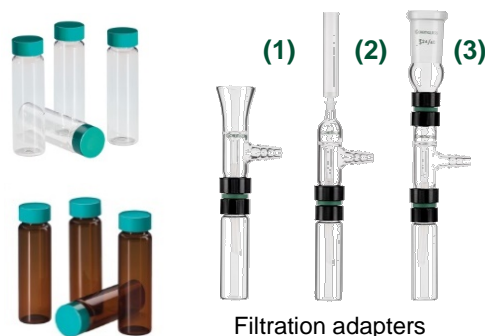

Cat. No.	Description	Unit
CG-4900-01	4 ml Sample Vial, Clear Glass, 13-425 Thread	144
CG-4900-02	8 ml Sample Vial, Clear Glass, 15-425 Thread	144
CG-4900-03	16 ml Sample Vial, Clear Glass, 18-400 Thread	144
CG-4900-04	20 ml Sample Vial, Clear Glass, 24-400 Thread	144
CG-4900-05	30 ml Sample Vial, Clear Glass, 24-400 Thread	144
CG-4900-06	40 ml Sample Vial, Clear Glass, 24-400 Thread	144
CG-4905-01	4 ml Sample Vial, Amber Glass, 13-425 Thread	144
CG-4905-02	8 ml Sample Vial, Amber Glass, 15-425 Thread	144
CG-4905-03	16 ml Sample Vial, Amber Glass, 18-400 Thread	144
CG-4905-04	20 ml Sample Vial, Amber Glass, 24-400 Thread	144
CG-4905-05	30 ml Sample Vial, Amber Glass, 24-400 Thread	144
CG-4905-06	40 ml Sample Vial, Amber Glass, 24-400 Thread	144

More vials with different capacities, thread sizes and a broad choice of caps available (including open top caps with septa and reaction vials with pressure relief caps).

Also available: Products for Chromatography Applications from J.G. Finneran



For detailed information please contact us.

Pressure Vessels

- Heavy wall borosilicate glass vessels for pressure reactions and applications
- **Working pressure: 60 PSI (4.15 bar)**
- Flask with internal thread and PTFE bushing as a pressure seal
- Allows hand tightening and loosening for easy access
- Complete vessel is supplied with vessel, back seal solid PTFE Bushing and Viton O-ring
- Separate tubes, Viton and Perfluoro O-rings and different PTFE Bushings available
- Cylindrical vessels with volumes up to 1 l available upon request



Cylindrical Tubes Complete

Cat. No.	OD x Length	Capacity	Bushing Size
CG-1880-01	25.4 x 114 mm	15 ml	# 15
CG-1880-02	25.4 x 190 mm	35 ml	# 15
CG-1880-03	25.4 x 215 mm	38 ml	# 15
CG-1880-04	38.0 x 114 mm	48 ml	# 15
CG-1880-05	38.0 x 190 mm	100 ml	# 15
CG-1880-06	38.0 x 215 mm	120 ml	# 15

Round Bottom Tubes Complete (egg-shaped)

Cat. No.	OD x Length	Capacity	Bushing Size
CG-1880-10	52.0 x 102 mm	75 ml	# 15
CG-1880-40	52.0 x 102 mm	75 ml	# 25
CG-1880-11	63.5 x 117 mm	150 ml	# 15
CG-1880-41	63.5 x 117 mm	150 ml	# 25
CG-1880-12	82.5 x 142 mm	350 ml	# 15
CG-1880-42	82.5 x 142 mm	350 ml	# 25

Round Bottom Tubes Complete (completely round, shaped similar to a round bottom flask)

Cat. No.	OD x Length	Capacity	Diameter Matches Round Flask Capacity	Bushing Size
CG-1880-R-01	48 x 85 mm	approx. 28 ml	50 ml	# 25
CG-1880-R-02	60 x 100 mm	approx. 65 ml	100 ml	# 25
CG-1880-R-03	85 x 125 mm	approx. 200 ml	250 ml	# 25
CG-1880-R-04	105 x 145 mm	approx. 420 ml	500 ml	# 25

PTFE Bushings with Viton o-rings

Cat. No.	Description
CG-363-03	Back Seal, Solid, # 15
CG-363-05	Back Seal, Solid, # 25
CG-366-12	Front Seal, Solid, # 15
CG-366-13	Front Seal, Solid, # 25
CG-362-03	Front Seal, Open Top, # 15
CG-362-05	Front Seal, Open Top, # 25
CG-364-40	Front Seal, 1/8" Female NPT, # 15
CG-364-60	Front Seal, 1/8" Female NPT, # 25



PTFE Bushings: Back Seal (left side) and Front Seal (right side)

Pressure vessels are tested at 150 PSI (10,34 bar) or approximately 2,5 times their recommended working pressure of **60 PSI (4,15 bar)**. However, we do not guarantee the vessels from breaking under pressure due to the nature of the material and conditions beyond our control. We recommend the use of safety shields and/or other safety utensils.

Microwave Reaction Vials

- Heavy wall borosilicate glass vials
- **Withstand pressure up to 300 PSI (20 bar)**
- All sizes are supplied with 20 mm aluminum seals with 0,125" (3,18 mm) thick PTFE faced silicone septa
- PTFE-coated stir bars are used to provide continuous stirring and even heating
- Crimper and Decapper: please see page 25
- Complete packages contain vials, stir bars and aluminium seals with septa



Complete Packages:

CG-4920-04	100 pcs. 0,2 - 0,5 ml vials, 100 pcs. 20 mm aluminium seals with septa, 100 pcs. 2 mm diameter x 5 mm long PTFE stir bars
CG-4920-03	100 pcs. 0,5 - 2,0 ml tapered vials, 100 pcs. 20 mm aluminium seals with septa, 100 pcs. 5,25 mm width x 11 mm height triangular shaped PTFE stir vanes
CG-4920-01	100 pcs. 2,0 - 5,0 ml round bottom vials, 100 pcs. 20 mm aluminium seals with septa, 100 pcs. 3 mm diameter x 10 mm long PTFE stir bars
CG-4920-02	100 pcs. 10,0 - 20,0 ml round bottom vials, 100 pcs. 20 mm aluminium seals with septa, 12 pcs. 6 mm diameter x 15 mm long egg shaped PTFE stir bars

Cat. No.	OD x Length	Capacity	Vial Form
CG-4920-04*	8 x 83 mm	0,2 - 0,5 ml	---
CG-4920-03	16 x 83 mm	0,5 - 2,0 ml	Tapered
CG-4920-01	16 x 83 mm	2,0 - 5,0 ml	Round
CG-4920-02	28 x 83 mm	10,0 - 20,0 ml	Round

* Vials (0,2 – 0,5 ml) require a PEEK adapter collar to attach crimp seals. The adapter is available on request.

Replacement Components

Cat. No.	Description	Cs.
CG-4920-10	20 mm aluminum seals, 0.125" (3.18 mm) thick PTFE faced silicone septa	200
CG-4920-15	3 mm diameter x 10 mm long PTFE stir bars	50
CG-4920-16	6 mm diameter x 15 mm long egg shaped PTFE stir bars	12
CG-4920-17	5,25 mm width x 11 mm height triangular shaped PTFE stir vanes	50
CG-4920-18	2 mm diameter x 5 mm long PTFE stir bars	50

Airfree® products from Chemglass: please enquire

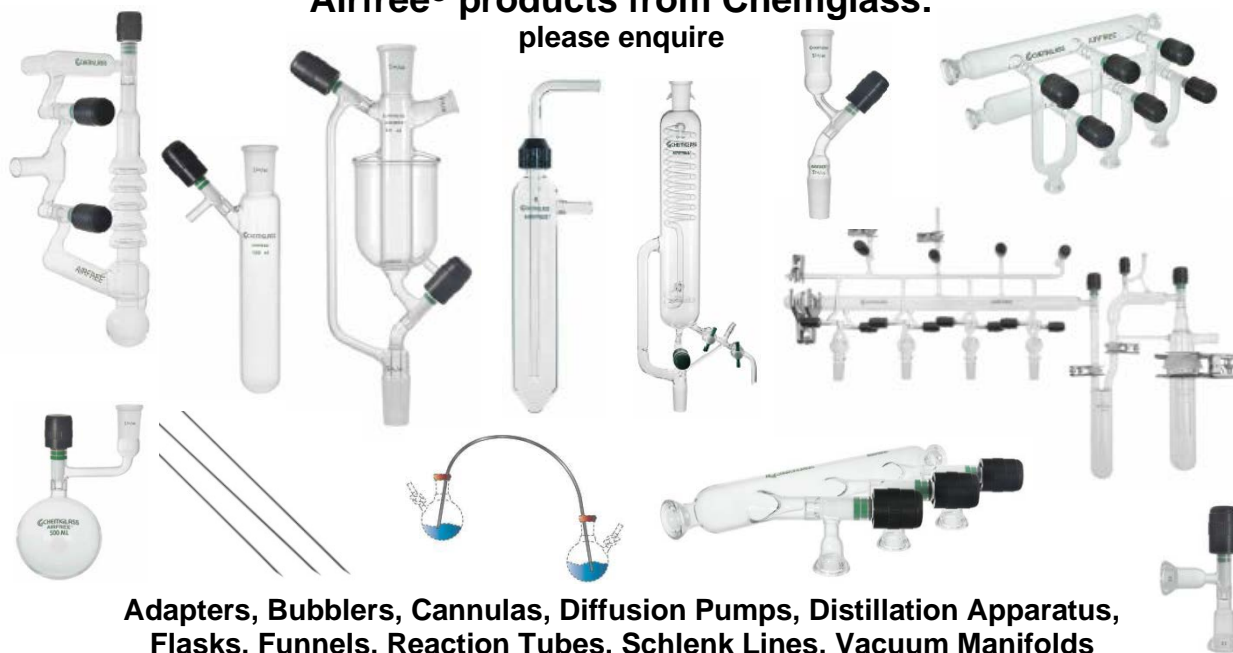

Adapters, Bubblers, Cannulas, Diffusion Pumps, Distillation Apparatus, Flasks, Funnels, Reaction Tubes, Schlenk Lines, Vacuum Manifolds

Filter Funnel with Vacuum Adapter and Stopcock

- Disposable filter funnel system for solid-liquid separation
- Polypropylene filter funnel with a polyethylene fritted disc
- Polyethylene fritted disc plus diatomaceous earth (OP-6603) or plus silica gel (OP-6604) available
- To be used with CG-1049-J style glass vacuum adapter and a flask/vial
- Vacuum Adapter contains:
 - standard joint on top for connection of filter funnel and a taper inner joint or a vial thread
 - 2 mm PTFE stopcock for vacuum
- Suitable Connectors please see CG-1318 on page 42



Cat. No.	Volume	Fritted Disc	Funnel Style	Cs.
OP-6602-10	18 ml	Polyethylene (PE), 10 µm	flared top	100
OP-6602-12	40-60 ml	Polyethylene (PE), 10 µm	flared top	100
OP-6602-13	40-60 ml	Polyethylene (PE), 40 µm	flared top	100
OP-6602-14	110 ml	Polyethylene (PE), 10 µm	straight	50
OP-6602-16	300 ml	Polyethylene (PE), 40 µm	straight	30
OP-6602-18	500 ml	Polyethylene (PE), 40 µm	straight	20
OP-6603-10	18 ml	PE/Diatomaceous Earth, 0,5 g	flared top	50
OP-6603-12	40-60 ml	PE/Diatomaceous Earth, 1,5 g	flared top	50
OP-6603-13	150 ml	PE/Diatomaceous Earth, 5,0 g	straight	30
OP-6604-20	18 ml	PE/Silica Gel, 0,6 g	flared top	50
OP-6604-60	40-60 ml	PE/Silica Gel, 2,5 g	flared top	50
OP-6604-150	150 ml	PE/Silica Gel, 7,0 g	straight	30
OP-6605-08	8 ml	Polyethylene (PE), 10 µm	conical	100
OP-6605-10	20 ml	Polyethylene (PE), 10 µm	conical	100
OP-6605-12	60 ml	Polyethylene (PE), 10 µm	conical	100
CG-1049-J-14	Vacuum adapter with stopcock, to 14/20 Joint, glass			1
CG-1049-J-24	Vacuum adapter with stopcock, to 24/25 Joint, glass			1
CG-1049-J-29	Vacuum adapter with stopcock, to 29/26 Joint, glass			1
CG-1049-J-30	Vacuum adapter with stopcock, to 20-400 thread, glass			1

- Disposable filter funnel system for solid-liquid separation
- Polypropylene filter funnel with a polyethylene fritted disc
- To be used with CG-1049-M style glass vacuum adapter and a flask
- Vacuum Adapter contains a standard joint on top for connection of filter funnel and a taper inner joint



Cat. No.	Volume	Fritted Disc	Funnel Style	Cs.
OP-6602-J-20	2000 ml	Polyethylene (PE), 20 µm	barrel, funnel only	8
OP-6602-J-21	2000 ml	Polyethylene (PE), 20 µm	barrel, funnel with lid	8
OP-6602-J-50	Lid only for 2000 ml filter funnel			20

Vacuum Adapters and Connectors

Cat. No.	Description	Cs.
CG-1049-M-24	Vacuum adapter without stopcock, to 24/25 Joint, glass	1
CG-1049-M-45	Vacuum adapter without stopcock, to 45/50 Joint, glass	1

Buchner Funnels made of Porcelain



- Buchner funnels with fixed perforated plate
- Glazed inside and outside with the exception of the top rim
- Excellent resistance to all reagents except hydrofluoric acid
- Highly resistant to thermal shock
- Very low coefficient of expansion
- Table top funnel available

Cat. No.	Description	Filter Paper Size	Cs.
CG-1888-01	35 ml Buchner Funnel	35 - 40 mm	1
CG-1888-02	100 ml Buchner Funnel	50 - 55 mm	1
CG-1888-03	200 ml Buchner Funnel	70 mm	1
CG-1888-04	350 ml Buchner Funnel	90 mm	1
CG-1888-05	600 ml Buchner Funnel	110 mm	1
CG-1888-06	800 ml Buchner Funnel	110 - 124 mm	1
CG-1888-07	1.150 ml Buchner Funnel	142 - 150 mm	1
CG-1888-08	2.000 ml Buchner Funnel	185 mm	1
CG-1888-09	4.800 ml Buchner Funnel	240 mm	1
CG-1889-01	1.000 ml Buchner Funnel, table top	125 mm	1
CG-1889-02	2.000 ml Buchner Funnel, table top	200 mm	1

Crucibles from Porcelain



- Crucible with lid
- Glazed inside and outside with the exception of the outside base and rim
- Excellent resistance to all reagents except hydrofluoric acid
- Highly resistant to thermal shock
- Very low coefficient of expansion
- Low and tall form

Cat. No.	Description	Cs.
CG-1883-01	5 ml Crucible, low form	1
CG-1883-02	10 ml Crucible, low form	1
CG-1883-03	30 ml Crucible, low form	1
CG-1883-04	50 ml Crucible, low form	1
CG-1883-05	100 ml Crucible, low form	1
CG-1883-06	250 ml Crucible, low form	1
CG-1883-07	500 ml Crucible, low form	1
CG-1882-01	5 ml Crucible, tall form	1
CG-1882-02	10 ml Crucible, tall form	1
CG-1882-03	25 ml Crucible, tall form	1
CG-1882-04	50 ml Crucible, tall form	1
CG-1882-05	100 ml Crucible, tall form	1
CG-1882-06	250 ml Crucible, tall form	1

Jacketed Beakers, Borosilicate Glass



- Designed for use in temperature controlled reactions
- Hose connections: 10 mm OD at the largest serration
- Tall beakers have a conical interior bottom to help eliminate spinout when used with egg shaped spinbar
- Low form beakers
 - width to height ratio of 2:1
 - flat bottom on inner and outer vessel

Cat. No.	Description	Inner Ø x Height (mm)	Outer Ø x Height (mm)	Cs.
CG-1103-01	50 ml Jacketed Beaker, conical bottom	37 x 67	60 x 77	1
CG-1103-02	100 ml Jacketed Beaker, conical bottom	47 x 59	75 x 73	1
CG-1103-03	250 ml Jacketed Beaker, conical bottom	65 x 100	90 x 115	1
CG-1103-04	500 ml Jacketed Beaker, conical bottom	80 x 130	110 x 145	1
CG-1103-05	1.000 ml Jacketed Beaker, conical bottom	105 x 142	140 x 155	1
CG-1103-06	2.000 ml Jacketed Beaker, conical bottom	119 x 190	150 x 220	1
CG-1107-10	Jacketed Beaker, low form, flat bottom	100 x 50	135 x 70	1
CG-1107-11	Jacketed Beaker, low form, flat bottom	150 x 75	190 x 95	1
CG-1107-12	Jacketed Beaker, low form, flat bottom	200 x 100	250 x 120	1

Sublimation Apparatus and Sublimation Flask Adapters

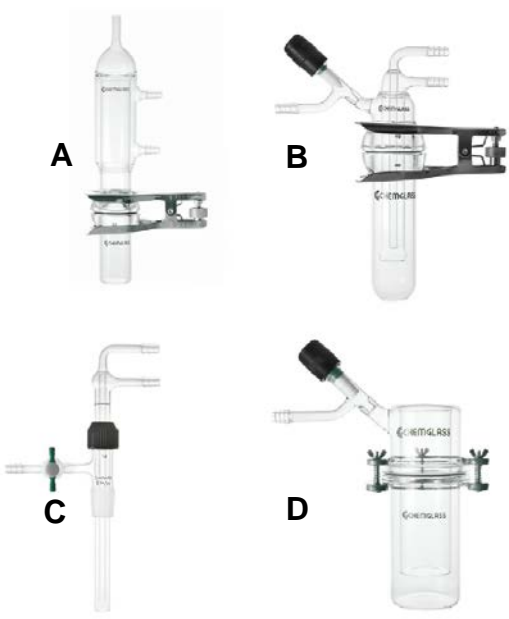

- For purification and separation by combined sublimation and deposition processes
- Available in different styles (A-D) with capacities ranging from 10 ml to 1L (depending on model)
- Grease-free assemblies for vacuum applications

Complete assemblies include Viton o-rings, clamps and the following components:

Style A: tube-like condenser, condenser flask (top vacuum connection can be used as funnel for sublimate removal)

Style B: cold finger condenser, condenser flask, 0-4 mm Chem-Vac™, Chem-Cap® Valve

Style C: cold finger condenser with standard tapered joint, (Joint size: 24/25) with 2 mm PTFE stopcock for vacuum control, Chem-Thread Compression Cap with Aperture

Style D: cold finger condenser, 80 mm flange, Chem-Cap® valve

Cat. No.	Description	Cs.
CG-3034-01	Sublimator, style: Dailey, (B), Complete, <u>water-cooled</u> , Capacity: 10 ml	1
CG-3034-02	Sublimator, style: Dailey, (B), Complete, <u>water-cooled</u> , Capacity: 40 ml	1
CG-3036-01	Sublimation Apparatus, (style A), Complete, <u>water-cooled</u> , Capacity 15 ml	1
CG-3036-02	Sublimation Apparatus, (style A), Complete, <u>water-cooled</u> , Capacity 50 ml	1
CG-3038-01	Sublimation Apparatus (style D), Complete, to be <u>cooled</u> either <u>with dry ice, acetone or liquid nitrogen</u> , Capacity: 150 ml	1
CG-3032-01	Sublimation Adapter (style C), <u>water-cooled</u> , for use with standard reaction flasks (250 ml – 1L)	1

Please ask for further information and additional products from Chemglass Life Sciences:

Airfree® Products, Adapters, Bubblers, Cannulas, Crystallizing Dishes, Condenser, Coolers, Diffusion Pumps, Distillation Apparatus, Flasks, Gas Scrubbers, Petri Dishes, Process Reactors, Pyrex® Products, Schlenk Lines, Tubings, Vacuum Manifolds and much more.

Beakers made of Stainless Steel



- Easy to clean seamless construction of non-corrosive stainless steel, grade 304
- Flared edge with spout for a simple transfer of liquids
- Suitable tong for easy handling

Cat. No.	Description	Cs.
CG-1109-M-125	125 ml Beaker, Griffin, stainless steel	1
CG-1109-M-250	250 ml Beaker, Griffin, stainless steel	1
CG-1109-M-600	600 ml Beaker, Griffin, stainless steel	1
CG-1109-M-1200	1.200 ml Beaker, Griffin, stainless steel	1
CG-1109-M-2000	2.000 ml Beaker, Griffin, stainless steel	1
CG-1109-M-4000	4.000 ml Beaker, Griffin, stainless steel	1
CG-1105-100	Beaker Tong, length 38 cm, jaws covered with ceramic fabric	1

Beakers with Handle made of Stainless Steel



- Easy to clean seamless interior stainless steel, grade 316, polished 10 Ra finish
- Solid handle
- Spout for easy transfer of liquids
- Graduation marks (without numbers)

Cat. No.	Description	Cs.
CG-1109-X-1000	1.000 ml Beaker with handle, stainless steel	1
CG-1109-X-2000	2.000 ml Beaker with handle, stainless steel	1
CG-1109-X-3000	3.000 ml Beaker with handle, stainless steel	1
CG-1109-X-5000	5.000 ml Beaker with handle, stainless steel	1

PTFE Beakers and Covers, withstand high temperatures



- Chemically inert PTFE beakers withstand temperature up to 260 °C
- Heatable beakers combine a PTFE body with a specially formulated stabilized PTFE carbon base in a single molding for improved heat transfer, heatable up to 270 °C without distortion

Cat. No.	Description	Cs.
CG-1109-01	50 ml Beaker, PTFE	1
CG-1109-02	100 ml Beaker, PTFE	1
CG-1109-10	150 ml Beaker, PTFE	1
CG-1109-03	250 ml Beaker, PTFE	1
CG-1109-04	500 ml Beaker, PTFE	1
CG-1109-05	1.000 ml Beaker, PTFE	1
CG-1109-06	2.000 ml Beaker, PTFE	1
CG-1109H-01	100 ml Beaker, PTFE, heatable	1
CG-1109H-02	250 ml Beaker, PTFE, heatable	1
CG-1109H-03	400 ml Beaker, PTFE, heatable	1
CG-1109C-01	Cover for 50 ml Beaker, PTFE	1
CG-1109C-02	Cover for 100 ml Beaker, PTFE	1
CG-1109C-03	Cover for 150 ml Beaker, PTFE	1
CG-1109C-04	Cover for 250 ml Beaker, PTFE	1
CG-1109C-05	Cover for 500 ml Beaker, PTFE	1
CG-1109C-06	Cover for 1.000 ml Beaker, PTFE	1
CG-1109C-07	Cover for 2.000 ml Beaker, PTFE	1

Evaporating Dishes made of PTFE



- Isostatically molded in pure, FDA approved PTFE
- Totally chemically resistant and inert
- Super smooth internal finish
- Flat or tall form
- Flat form with or without spout

Cat. No.	Description	Form	Cs.
CG-8276F-01	25 ml Evaporating Dish, PTFE	flat	1
CG-8276F-02	50 ml Evaporating Dish, PTFE	flat	1
CG-8276F-03	100 ml Evaporating Dish, PTFE	flat	1
CG-8276F-04	350 ml Evaporating Dish, PTFE	flat	1
CG-8278P-01	25 ml Evaporating Dish, PTFE	flat with spout	1
CG-8278P-02	50 ml Evaporating Dish, PTFE	flat with spout	1
CG-8278P-03	100 ml Evaporating Dish, PTFE	flat with spout	1
CG-8278P-04	350 ml Evaporating Dish, PTFE	flat with spout	1
CG-8276T-01	25 ml Evaporating Dish, PTFE	tall with spout	1
CG-8276T-02	50 ml Evaporating Dish, PTFE	tall with spout	1
CG-8276T-03	100 ml Evaporating Dish, PTFE	tall with spout	1
CG-8276T-04	350 ml Evaporating Dish, PTFE	tall with sprout	1

Bottles made of PTFE



- Isostatically molded in pure, FDA approved PTFE
- Totally chemically resistant and inert
- Heavy wall construction with super smooth internal finish
- Leak-free screw cap
- Grooves for easy handling
- Heatable up to 280 °C, suitable for low temperature applications

Cat. No.	Description	Cs.
CG-854-T-50	50 ml Bottle, PTFE	1
CG-854-T-100	100 ml Bottle, PTFE	1
CG-854-T-150	150 ml Bottle, PTFE	1
CG-854-T-250	250 ml Bottle, PTFE	1
CG-854-T-500	500 ml Bottle, PTFE	1
CG-854-T-1000	1.000 ml Bottle, PTFE	1

Jars made of PTFE



- Isostatically molded in pure, FDA approved PTFE
- Totally chemically resistant and inert
- Heavy wall construction with super smooth internal finish

Cat. No.	Description	Cs.
CG-8656-T-30	30 ml Jar, PTFE	1
CG-8656-T-60	60 ml Jar, PTFE	1
CG-8656-T-120	120 ml Jar, PTFE	1
CG-8656-T-240	240 ml Jar, PTFE	1
CG-8656-T-360	360 ml Jar, PTFE	1
CG-8656-T-480	480 ml Jar, PTFE	1

Components for Applikon® and Broadley-James® Bioreactors



- Available in 2, 3, 5, 7 and 15 l sizes
- Like-for-like replacement parts for Applikon® und Broadley-James® brands of bioreactors
- Clear glass vessel is made from heavy wall, borosilicate glass for superior visibility and resistance to thermal shock and corrosion. Marked with permanent white graduation
- Jacketed vessels and red stained vessels available. Stain allows less than 1 % of light transmission below 400 nm
- Stainless steel components manufactured from 316L with an electropolished surface finish of 20Ra or better
- Head plate with up to 19 ports of different sizes, manufactured as a single piece and supplied with a silicone o-ring
- Impeller blades - Ruston and Marine style available

Applikon® is a registered trademark of Applikon Biotechnology, Inc. Broadley-James® is a registered trademark of Broadley James Corporation

Cat. No.	Description	Cs.
CLS-1380-01	Bioreactor vessel, 3 l, unjacketed, clear	1
CLS-1381-01	Bioreactor vessel, 3 l, jacketed, clear, GL18 glass threads, with caps and hose connections	1
CLS-1380-STD3	Tripod stand for unjacketed vessel (3 l)	1
CLS-1381-STD3	Tripod stand for jacketed vessel (3 l)	1
CLS-1380-03	Headplate, stainless steel (316L), supplied with silicone O-ring, 18 total ports: central M30, 1 x G3/4, 5 x M18, 2 x M12, 6 x M10, 3 x M6	1
CLS-1380-100	Headplate assembly stand	1
CLS-1380-05	Agitator assembly, stainless steel (316L), shaft (L x Ø) 222 x 8 mm	1
CLS-1380-06	Impeller Blade, Marine style, Vortex (Down), Ø 43 mm, Shaft Ø 8 mm	1
CLS-1380-07	Impeller Blade, Marine style, Scoping (Up), Ø 43 mm, Shaft Ø 8 mm	1
CLS-1380-08	Impeller Blade, Rushton style, Ø 48 mm, Shaft Ø 8 mm	1
CLS-1380-57	Double port adapter, M18, 2 x 4 mm outer diameter tubing ports	1
CLS-1380-09	Triple port adapter, M18, 3 x 1/8" tubing ports, inlets staggered in height	1
CLS-1380-10	Septum holder, M18, supplied with silicone rubber septum, for injections	1
CLS-1380-014	Replacement septa, silicone rubber, for CLS-1380-10	10
CLS-1380-11	Thermowell for 1/4" thermocouples, M10, 0,31" ID, immersion length 200 mm	1
CLS-1380-12	Aeration tube, M10, sintered (15 µm) sparger, immersion length 238 mm	1
CLS-1380-20	Air inlet / adapter, M10	1
CLS-1380-21	Sampling tube, M10, adjustable, max. immersion length 232 mm, tubing OD ¼"	1
CLS-1380-70	Sampling tube, large diameter, M18, 1/2" diameter, 212 mm length	1
CLS-1380-22	Blind stoppers, M6, fitted from the inside	1
CLS-1380-23	Blind stoppers, M10, fitted from the inside	1
CLS-1380-25	Blind stoppers, M18, fitted from the inside	1
CLS-1380-28	Heat exchanger, cold finger style, M18	1
CLS-1380-31	Addition pipe, M10	1
CLS-1380-32	Harvest tube, M10, tapered tip extends to within 2 mm of the bottom of the vessel	1
CLS-1380-92	Level sensor adapter, M10, for 1/4" outer diameter level sensors	1
CLS-1381-04	Baffle assembly, M6, increases mixing efficiency	1
CLS-1381-06	Probe holder, M18, height adjustable with compression fitting, for 12 mm probes	1
CLS-1380-GC1	Condenser, glass, 12 mm OD stem, for use with CLS-1381-06	1
CLS-1380-27	Condenser, stainless steel with internal baffle, for use with CLS-1381-06	1
CLS-1399-100E	Stirrer with controller, 240 W, 10 - 800 U/Min, 643 mNm, RS-232 port	1

For other bioreactor types and sizes, we also have a large choice of further accessories: oxygen and pH probes, sin gle-use accessory kits, replacement O-rings, etc. Please contact us. Also please note page 9.

ChemRxnHub Benchtop and Large Capacity Process Reactors

ChemRxnHub benchtop process reactor systems come complete with benchtop stand, overhead stirrer and glassware. Manifold connection and heat transfer fluid draining system are optionally available. The unique design of the support stand and clamping system allows quick and easy installation/removal of glassware and fits into most benchtop hoods. For the parallel utilization of two or three reactors, dual and triple support stands are available.

For bigger volumes comparable systems up to 150 l can be offered based on your individual needs. Reactor vessels are available jacketed or unjacketed, and 50 l and 100 l vessels with a tall or low profile.

Filter reactors with volumes from 1 l to 50 l and distillation kits to be used in combination with our process reactors can be offered.

For individualized systems a broad choice of reaction vessels down to 100 ml with/without drain valve and with/without baffles as well as a range of glass or PTFE lids with 3 to 9 necks are available.

For all process reactors a big variety of accessories like adapters, circulators, glassware, heating mantles, probes, and sensors are available or can be manufactured according to your individual requirements.



Single, dual and triple support stands available



ChemRxnHub benchtop process reactors

- Available sizes: 300 ml, 500 ml, 1 l, 2 l and 5 l
- Jacketed reactor vessels
- Systems include glassware, a digital overhead stirrer and a stand
- Optional: Inlet and outlet manifold assemblies including triple insulated hose for connection to the vessel jacket

Large capacity process reactors

- Capacities of up to 150 l
- Jacketed and unjacketed reactor vessels
- Tall or low profile vessels for 50 l and 100 l capacities
- Support frames for 75 l, 100 l systems and one 150 l model include safety shields