

**Bellco Glass**  
Equipment, Glass and Consumables  
**Product Information**  
- prices on request -



## Index \*)

	<b>Page</b>
Anaerobic Tubes: Balch Type and Hungate Type	28
Anaerobic Culture Bottles	23
Aseptic Filling Bell	16
Autoblot® Hybridization Ovens	35
Bell-ennium™ Magnetic Stirrers	12-13
Biometrical Flasks	23
Bioreactor Vessels, Spinner Flasks and Accessories	6, 8, 11
Bottles/Flasks	19-24, 35, 36
<hr/>	
Caps/Pouring Rings, Membrane, GL32/45	10
Centrifugation Tubes	27
Chromatography Products (J.G. Finneran)	16
Cloning Cylinders	16
Closures:	10, 14-15
Stainless Steel, Silicone Sponge, KAP-UTS™, Pouring Rings, Plugs, Screw Caps	
Cover Slips and Microscope Slides:	17-18
Round, Rectangular, Square, Photo-etched	
Culture Chamber, Sykes-Moore	18
Culture Tubes:	27-28
Anaerobic, Hungate-, Leighton-, with Screw Caps, Gas Fermentation	
Disinfectant Testing Glazed Cylinder	16
<hr/>	
Flasks/Bottles:	19-24, 35, 36
Anaerobic, Biometer, Culture-, DeLong®, Erlenmeyer, Fernbach-, Hybridization-, Nephelo-, Probe-, Roller, Roux-, Shake-, Trypsinizing-, Volumetric-, Narrow/Wide Mouth	
Glass Bells for Aseptic Filling	16
Homogenizer:	25-26
Collector™ Tissue Sieve,	25
Conical, Dounce, Potter-Elvehjem, Tenbroeck, Overhead Drive, BioVortexer	25-26
Hungate Culture Tubes	28
Hybridization Ovens and Bottles	35
Incubators, Benchtop, (Refrigerated) Roll-In, Large Capacity	37-40
<b>Insect Cell Culture Systems</b>	11
KAP-UTS™ Closures	15
<hr/>	
Leighton Culture Tubes	28
Magnetic Stirrer:	12-13
Bell-ennium™ and Bel-Stir	
Microscope Slides and Cover Slips	17-18
Overhead Drives and Accessories	11, 26
Pan Hot Shakers (single and dual pans)	32
Pipettes, Glass, Serological, "Shorties"	30
Pipette Cans, stainless steel and glass	30-31
Pipette Plugger and Cotton Roving	31
Port Assemblies	9, 10, 14
Rocker, Mixer and Shaker	33-34
<b>Roller Apparatus and (Refrigerated) Roll-In Incubators</b>	37-40
Roller Bottles	36
Roller Drums	32
<hr/>	
Septa	10
Shaker/Rocker and Accessories	32-34
Orbital-, Reciprocating-, Linear-, Mini Orbital-, Single and Dual Pan	
Slides:	18
Plain, Frosted, Multispot, Counting Slides: Reich-, Somatic Cell-, Fluorescent Antibody-	
Spargers	9
<b>Spinner Flasks, Bioreactor Vessels and Accessories:</b>	3-13
Hanging Bar-, BioProbe™-, BELL-FLO™-, Glass Ball-, MicroCarrier-, Bioreactors,	
Internal Overhead Bearing Impeller, Overhead Drives,	
Water Jacketed, Magnetic Stirrers	
Sponge Closures, Silicone	14
Sykes-Moore Chamber	18
Trypsinizing Flasks	23
Tubes: Anaerobic, Balch, Centrifuge, Culture, Gas Fermentation, Hungate, Leighton	27-28
Tube Racks	29
Tube Roller	13
Vortexer, Motor and Accessories	26

\*) **This is only an excerpt from Bellico's broad product portfolio.  
You want to find out more about Roller Apparatus, Incubators and Bioreactors?  
Please enquire for further details.**

# Spinner Flasks, Bioreactor Vessels and Accessories

**NEW: Spinner Flask with 60 liter volume on request!**

## MicroCarrier Spinner Flask

- Promote optimal growth of suspension and microcarrier cultures
- Ideal for insect culture with reduced volume and increased oxygen demand
- Spinners ensure optimal stirring of microcarriers or cell suspensions at low speed
- Indented bottom (up to 1 l) prevents accumulation of microcarrier beads under impeller
- To be used with overhead drive motors (stirring from above) or magnetic stirrers (stirring from below)
- Impeller height adjusts through compression fitting in cap
- Flasks available complete or as separate components
- Optional accessories available: e.g. pH, DO, gas probes
- "Complete": Flask, centre cap with opening for impeller, impeller, two side-arm caps



Cat.-No.	Description	Centre/Side-arm Caps	Ø x Height
1965-00100	100 ml, Complete	70/32 mm	64 x 135 mm
1965-00250	250 ml, Complete	70/32 mm	83 x 140 mm
1965-00500	500 ml, Complete	70/45 mm	110 x 180 mm
1965-02500	500 ml, Complete	100/45 mm	110 x 180 mm
1965-01000	1.000 ml, Complete	100/45 mm	135 x 250 mm
1965-03000	3.000 ml, Complete	100/45 mm	165 x 280 mm
1965-06000	6.000 ml, Complete	100/45 mm	204 x 410 mm
1965-08000	8.000 ml, Complete	100/45 mm	237 x 430 mm
1965-15000	15.000 ml, Complete	100/45 mm	294 x 460 mm
1965-36000	36.000 ml, Complete	100/45 mm	410 x 535 mm

## Replacement parts (sold separately) for 1965-Series Spinner Flasks

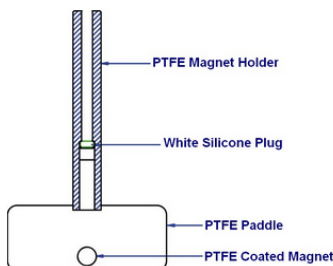

For Cat. No.	Flask*	Impeller**	Glass Shaft	Cap#
1965-00100	1965-10100	1965-30100	1969-70250	1965-90070
1965-00250	1965-10250	1965-30100	1969-70250	1965-90070
1965-00500	1965-10500	1965-30500	1969-70500	1965-90070
1965-02500	1965-20500	1965-30500	1969-70500	1965-90100
1965-01000	1965-11000	1965-31000	1969-71000	1965-90100
1965-03000	1965-13000	1965-31000	1969-73000	1965-90100
1965-06000	1965-16000	1965-38000	1965-78000	1965-99100
1965-08000	1965-18000	1965-38000	1965-78000	1965-99100
1965-15000	1965-11500	1965-31500	1965-71500	1965-99100
1965-36000	1965-13600	1965-31500	1965-71500	1965-99100

For Cat. No.	Stainless Steel Shaft
1965-00100	1969-60100
1965-00250	1969-60250
1965-00500	1969-60500
1965-02500	1969-60500
1965-01000	1969-61000
1965-03000	1969-63000
1965-06000	1969-66000
1965-08000	1969-66000
1965-15000	1969-61500
1965-36000	1969-61500

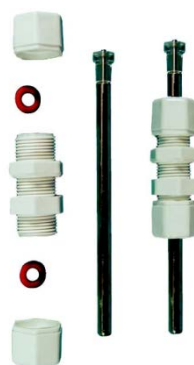

Flask\* = with side-arm caps, and (for 500 ml and larger) pouring rings  
 Impeller\*\* = imp. magnet, magnet holder, paddle, silicone plug  
 Cap# = screw cap, liner and compression fitting

## Replacement Parts for 1965-Series Spinner Flasks (continued)

Cat. No.	Description
A523-204	Compression Fitting, Black PP, 7 mm
A523-218	Compression Fitting, Black PP, 9 mm
A523-939	Compression Fitting, White PP, for SST Shafts
A523-233	O-ring for Compression Fitting, 7 mm (for 100 ml - 3 l Flasks)
A523-234	O-ring for Compression Fitting, 9 mm (for 6 - 36 l Flasks)
A523-407	O-ring for Compression Fitting for SST Shafts
A523-200	Silicone plug (for 100 ml - 3 l Flasks)
A523-213	Silicone plug (for 6 - 36 l Flasks)
A523-198	Paddle (100 ml und 250 ml Flasks)
A523-199	Paddle (500 ml Flasks)
A523-206	Paddle (1 l und 3 l Flasks)
A523-242	Paddle (6 l und 8 l Flasks)
A523-235	Paddle (15 l und 36 l Flasks)
A523-203	70 mm Cap, blue, PP, with hole
A523-205	70 mm Gasket, white, silicone, with hole
A523-208	100 mm Cap, blue, PP, with hole (500 ml - 3 l Flasks)
A523-209	100 mm Gasket, white, silicone, with hole (500 ml - 3 l Flasks)
A523-216	100 mm Cap, blue, PP, with hole (6 l - 36 l Flasks)
A523-217	100 mm Gasket, white, silicone, with hole (6 l - 36 l Flasks)

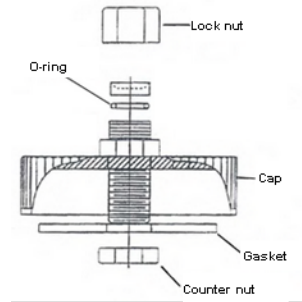

## Spinner Flasks with Internal Overhead Bearing Impeller (IOB)

- Internal impeller (IOB) decreases risk of contamination through cap
- Sealed internal assembly requires less incubator space
- Stainless steel shaft design prevents cell damage and minimizes magnetic decoupling
- Adjustable shaft aligns paddle with bottom of flask
- Large paddle promotes increased oxygenation with low shear
- Available as standard or water jacketed flasks (page 6)
- "Complete": Flask, Centre cap with impeller, two side-arm caps



Cat. No.	Description	Centre/Side-arm Caps	Ø x Height
1965-61001	100 ml, Complete	70/32 mm	65 x 135 mm
1965-61002	250 ml, Complete	70/32 mm	85 x 140 mm
1965-61005	500 ml, Complete	70/45 mm	110 x 180 mm
1965-61015	500 ml, Complete	100/45 mm	110 x 180 mm
1965-61010	1.000 ml, Complete	100/45 mm	135 x 250 mm
1965-61030	3.000 ml, Complete	100/45 mm	165 x 280 mm
1965-61060	6.000 ml, Complete	100/45 mm	204 x 410 mm
1965-61080	8.000 ml, Complete	100/45 mm	237 x 430 mm
1965-61150	15.000 ml, Complete	100/45 mm	294 x 460 mm
1965-61360	36.000 ml, Complete	100/45 mm	410 x 535 mm

## Impeller Assembly, Internal Overhead Bearing Impeller (IOB)

- For use with Bellco 1965-series Standard and Water Jacketed (page 6) Spinner Flasks
- Sealed internal assembly requires less incubator space
- Stainless steel shaft design prevents cell damage and minimizes magnetic decoupling
- 3 l and up include adjustable additional paddle blades (see right picture)

Cat. No.	Flask	Cap
1965-60001	100 und 250 ml	70 mm
1965-60015	500 ml	70 mm
1965-60005	500 ml	100 mm
1965-60010	1.000 ml	100 mm
1965-60030	3.000 ml	100 mm
1965-60060	6.000 ml	100 mm
1965-60080	8.000 ml	100 mm
1965-60150	15.000 ml	100 mm
1965-60360	36.000 ml	100 mm



## Adjustable PTFE Microcarrier Paddle Blades Only

- Additional paddle enhances mixing in larger spinner flasks (IOB) - see above
- Component of 3 l and larger internal overhead bearing impeller (IOB) - see above

Cat. No.	Flask Size	Paddle Dimensions
1965-40003	1 l - 3 l	38,1 x 108,0 mm
1965-40008	6 l - 8 l	38,1 x 162,1 mm
1965-40036	15 l - 36 l	38,1 x 85,9 mm
1965-40136	15 l - 36 l	38,1 x 241,3 mm



## BELL-FLO™ Spinner Flasks

- Bottom indent and three vertical baffles provide optimal mixing
- Unique PTFE paddle design promotes culture aeration
- Rugged stainless steel/PTFE internal bearing assemblies
- 32 mm or 45 mm side-arms for connection of adapters, probes and tubes
- “Complete”: Flask, centre cap with impeller, two side-arm caps
- “Flask only”: Flask with two side-arm caps
- “Impeller only”: Centre cap with fixed impeller



Cat. No.	Description	Centre/Side-arm Caps	Ø x Height
1965-80105	100 ml, Complete	70/32 mm	65 x 150 mm
1965-80255	250 ml, Complete	70/32 mm	85 x 150 mm
1965-80575	500 ml, Complete	70/45 mm	110 x 187 mm
1965-80515	500 ml, Complete	100/45 mm	110 x 187 mm
1965-81005	1.000 ml, Complete	100/45 mm	135 x 245 mm
1965-83005	3.000 ml, Complete	100/45 mm	165 x 295 mm
1965-80100	100 ml, Flask only	70/32 mm	65 x 135 mm
1965-80250	250 ml, Flask only	70/32 mm	85 x 140 mm
1965-80570	500 ml, Flask only	70/45 mm	110 x 175 mm
1965-80510	500 ml, Flask only	100/45 mm	110 x 170 mm
1965-81000	1.000 ml, Flask only	100/45 mm	135 x 240 mm
1965-83000	3.000 ml, Flask only	100/45 mm	165 x 290 mm
1965-80101	100 ml, Impeller only		
1965-80251	250 ml, Impeller only		
1965-80571	500 ml, Impeller only		
1965-80511	500 ml, Impeller only		
1965-81001	1.000 ml, Impeller only		
1965-83001	3.000 ml, Impeller only		

## Glass Ball Spinner Flask

- Specially formed bottom indent prevents accumulation under impeller
- Glass Ball houses a magnet for gentle agitation of microcarrier beads
- “Complete”: Flask, centre cap with glass ball impeller, 2 side-arm caps
- “Flask only”: Flask with two side-arm caps
- “Impeller only”: Centre cap with fixed glass ball impeller



Cat. No.	Description	Centre/Side-arm Caps	Ø x Height
1965-92001	100 ml, Complete	70/32 mm	65 x 135 mm
1965-92002	250 ml, Complete	70/32 mm	85 x 140 mm
1965-92005	500 ml, Complete	100/45 mm	110 x 180 mm
1965-92010	1.000 ml, Complete	100/45 mm	135 x 250 mm
1965-92030	3.000 ml, Complete	100/45 mm	165 x 280 mm
1965-92060	6.000 ml, Complete	100/45 mm	204 x 410 mm
1965-92080	8.000 ml, Complete	100/45 mm	237 x 430 mm
1965-94010	100 ml, Flask only	70/32 mm	65 x 135 mm
1965-94025	250 ml, Flask only	70/32 mm	85 x 140 mm
1965-94050	500 ml, Flask only	100/45 mm	110 x 180 mm
1965-94100	1.000 ml, Flask only	100/45 mm	135 x 250 mm
1965-94300	3.000 ml, Flask only	100/45 mm	165 x 280 mm
1965-94600	6.000 ml, Flask only	100/45 mm	204 x 410 mm
1965-94800	8.000 ml, Flask only	100/45 mm	237 x 430 mm
1965-95010	100 ml, Impeller only		
1965-95025	250 ml, Impeller only		
1965-95050	500 ml, Impeller only		
1965-95100	1.000 ml, Impeller only		
1965-95300	3.000 ml, Impeller only		
1965-95600	6.000 ml / 8.000 ml, Impeller only		

## Water Jacketed MicroCarrier Spinner Flasks

- Ideal for laboratories with limited space or without incubator capacity
- Requires circulating water bath or chiller unit and magnetic stirrer
- Can be used separately or in a row
- Hose connection: 9,5 mm (3/8") inner diameter (Except 8 l: 13 mm, 1/2" respectively)
- "Complete": Flask including centre cap with opening for impeller, impeller, two side-arm caps
- "Flask only": Flask, solid centre cap and two side-arm caps



Cat. No.	Description	Jacket Volume	Centre/Side-arm Caps
1965-50050	50 ml, Complete	40 ml	51/18 mm
1965-50100	100 ml, Complete	75 ml	70/18 mm
1965-50250	250 ml, Complete	175 ml	70/25 mm
1965-50500	500 ml, Complete	260 ml	70/38 mm
1965-51000	1.000 ml, Complete	875 ml	100/45 mm
1965-53000	3.000 ml, Complete	1.300 ml	100/45 mm
1965-56000	6.000 ml, Complete	3.700 ml	100/45 mm
1965-58000	8.000 ml, Complete	7.500 ml	100/45 mm
1965-50051	50 ml, Flask only	40 ml	51/18 mm
1965-50101	100 ml, Flask only	75 ml	70/18 mm
1965-50251	250 ml, Flask only	175 ml	70/25 mm
1965-50501	500 ml, Flask only	260 ml	70/38 mm
1965-51100	1.000 ml, Flask only	875 ml	100/45 mm
1965-53001	3.000 ml, Flask only	1.300 ml	100/45 mm
1965-56001	6.000 ml, Flask only	3.700 ml	51/18 mm
1965-58001	7.500 ml, Flask only	7.500 ml	70/18 mm

## Water Jacketed Spinner Flask with Internal Impeller

- Internal impeller decreases risk of contamination through cap
- Adjustable shaft aligns paddle with bottom of flask
- Large paddle promotes increased oxygenation with low shear
- Requires circulating water bath or chiller unit and magnetic stirrer
- "Complete": Flask, centre cap with impeller, 2 side-arm caps

Cat.-No.	Description	Jacket Volume	Centre/Side-arm Caps
1965-62001	100 ml, Complete	75 ml	70/18 mm
1965-62002	250 ml, Complete	175 ml	70/24 mm
1965-62005	500 ml, Complete	260 ml	70/38 mm
1965-62010	1.000 ml, Complete	875 ml	100/45 mm
1965-62030	3.000 ml, Complete	1.300 ml	100/45 mm
1965-62060	6.000 ml, Complete	3.700 ml	100/45 mm

## Low Profile Water Jacketed Bioreactor Vessels

- Ideal for use with water baths for precise temperature control
- 4 or 6 vertical side-arms, GL45
- Central opening 100 mm
- #4 Hose barbs for 1,27 cm (1/2") ID tubing
- Supplied with 100 mm PP centre cap, GL45 side-arm caps and pouring rings



Cat. No.	Description	Side-arms	Jacket Volume	Ø* x Height
1964-03440	3.000 ml	4	1.300 ml	300* x 280 mm
1964-03660	3.000 ml	6	1.300 ml	300* x 280 mm
1964-06440	6.000 ml	4	3.700 ml	300* x 325 mm
1964-06660	6.000 ml	6	3.700 ml	300* x 325 mm

\* add 100 mm for hose connections

## Water Jacketed Bioreactor Vessel, 8 Litre

- 4 or 6 vertical side-arms, GL45
- Graduated from 2 l through 8 l with marking spot
- Central opening 100 mm
- #4 Hose barbs for 1,27 cm (1/2") ID tubing
- Supplied with 100 mm PP central cap, GL45 side-arm caps and pouring rings



Cat. No.	Description	Side-arms	Jacket Volume	Ø x Height
1964-18040	8.000 ml	4	7.500 ml	300 x 450 mm
1964-18060	8.000 ml	6	7.500 ml	300 x 450 mm

## Adjustable Hanging Bar Spinner Flask with flat bottom

- Adjustable spinner height
- PTFE impeller assembly rides on glass bearing for friction-free operation
- 25 ml and 50 ml have black phenolic rubber-lined central and side-arm caps
- 100 ml to 3000 ml have blue polypropylene caps, silicone gasket and pouring rings
- "Complete": Flask including centre cap with opening for impeller, impeller, two side-arm caps



Cat. No.	Description	Centre/Side-arm Caps	Ø x Height
1967-00025	25 ml, Complete	38/18 mm	38 x 120 mm
1967-00050	50 ml, Complete	51/18 mm	55 x 110 mm
1967-00100A	100 ml, Complete	70/32 mm	69 x 110 mm
1967-00250	250 ml, Complete	70/32 mm	85 x 145 mm
1967-00500	500 ml, Complete	100/45 mm	110 x 185 mm
1967-01000	1.000 ml, Complete	100/45 mm	135 x 240 mm
1967-03000	3.000 ml, Complete	100/45 mm	165 x 290 mm

## Replacement Parts for 1967-Series Spinner Flasks



For Flask Cat. No.	Flask*
1967-00025	1967-10025
1967-00050	1967-10050
1967-00100	1967-10100
1967-00250	1967-10250
1967-00500	1967-10500
1967-01000	1967-11000
1967-03000	1965-13000



Impeller Assembly**
1967-30025
1969-30050
1969-30050
1969-30050
1969-30050
1969-30050
1969-31000
1969-31000



Glass Shaft
1969-70100
1969-70100
1969-70250
1969-70250
1969-70500
1969-71000
1969-73000

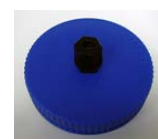

Cap #
1967-90038
1967-90051
1965-90070
1965-90070
1965-90100
1965-90100
1965-90100

\* Flask includes side-arm caps

\*\* Impeller assembly consists of magnet and magnet holder

# Supplied with liner and stopper (25 and 50 ml) or compression fitting (100 ml to 3 l)

## BioProbe™ Spinner Flasks

- Ideal for small working volumes
- Center cap: 100 mm
- Two upper side-arms: 45 mm
- Two lower side-arms: 32 mm
- Two lower side-arms slightly in front of the standard 45mm side-arms
- The 32 mm side-arms accept compression fittings that will allow 12 mm probes to be secured in the side-arm for monitoring of dissolved oxygen, pH, etc. (fittings and probes available on request)
- "Complete": Flask, 100 mm cap with impeller, two 45 mm and two 32 mm solid caps
- "Flask only": Flask with two 45 mm and two 32 mm solid caps
- "Impeller only": Centre cap with fixed stainless steel shaft and PTFE paddle



Cat. No.	Description	Minimal Volume	Ø x Height
1965-97005	500 ml, Complete	100 ml	165 x 295 mm
1965-97001	1.000 ml, Complete	200 ml	110 x 180 mm
1965-97003	3.000 ml, Complete	500 ml	135 x 245 mm
1965-97050	500 ml, Flask only	100 ml	110 x 175 mm
1965-97100	1.000 ml, Flask only	200 ml	135 x 240 mm
1965-97300	3.000 ml, Flask only	500 ml	165 x 290 mm
1965-60005	500 ml, Impeller only		
1965-60010	1.000 ml, Impeller only		
1965-60030	3.000 ml, Impeller only		

## 4-45™ Bioreactors

- 100 mm centre neck and four GL45 side-arms positioned 90°
- Stainless steel cap seal with compression fittings for insertion of 12 mm probes and 1/4" (0,64 cm) tubes
- Internal impeller assembly with stainless steel ball bearings and PTFE paddle
- Accepts standard connections and probes
- "Complete": Flask, centre SST Probe Cap Seal, internal impellar, 4 GL45 side-arm caps
- Stainless Steel Probe Cap Seal: 100 mm PP screw cap with 4 accessory ports around a centrally located internal impellar assembly, includes red silicone sealing gasket

Cat. No.	Description
1965-01400	1 l Bioreactor complete
1965-11400	1 l Flask with 4 GL45 side-arm caps
1965-60014	1 l Stainless Steel Probe Cap Seal, 4 Ports
1965-03400	3 l Bioreactor complete
1965-13400	3 l Flask with 4 GL45 side-arm caps
1965-60034	3 l Stainless Steel Probe Cap Seal, 4 Ports
1965-45200	45 mm Cap with 1/4" (0,64 cm) compression fitting and 1/4" (0,64cm) hose barb, includes white silicone gasket



## Vertical Side-arm Bioreactor Vessels

- Suitable for all cell culture and fermentation
- Compatible with Bellco overhead drives and magnetic stirrers
- 4 or 6 vertical side-arms with GL45 screw thread
- Supplied with 100 mm PP central cap, GL45 side-arm caps and pouring rings
- Optional baffles provide additional mixing



Cat. No.	Description	Baffles	Side-arms	Ø x Height
1964-08000	8.000 ml	0	4	240 x 430 mm
1964-08060	8.000 ml	0	6	240 x 430 mm
1964-08460	8.000 ml	4	6	240 x 430 mm
1964-15000	15.000 ml	0	4	295 x 460 mm
1964-15060	15.000 ml	0	6	295 x 460 mm
1964-15460	15.000 ml	4	6	295 x 460 mm
1964-36000	36.000 ml	0	6	410 x 535 mm
1964-36460	36.000 ml	4	6	410 x 535 mm

## Low Profile Vertical Side-arm Bioreactor Vessels

- Reduced height vessels maximize incubator space
- Suitable for all cell culture applications: Insect, Plant and Bacterial
- 4 or 6 vertical side-arms with GL45 screw thread
- 100 mm neck takes drive adapter and overhead drive motor
- Supplied with 100 mm PP central cap, GL45 side-arm caps and pouring rings
- To be used with 8 l heating blanket and flask carriers



Cat. No.	Description	Side-arms	Ø x Height
1964-03400	3.000 ml, Low Profile	4	240 x 250 mm
1964-03600	3.000 ml, Low Profile	6	240 x 250 mm
1964-06400	6.000 ml, Low Profile	4	240 x 295 mm
1964-06600	6.000 ml, Low Profile	6	240 x 295 mm

## Flask Carriers for Spinner Flasks and Vertical Side-arm Bioreactor Vessels

- Rugged stainless steel construction with base plate and handles
- Rubber feet for added stability

Cat. No.	Flask / Carboy	Height x Ø
7669-06000	6 l / 9 l	203,2 x 228,6 mm
7669-08000	8 l / 13 l	254,0 x 279,4 mm
7669-15000	15 l / 19 l	279,4 x 304,8 mm
7669-36000	36 l / 45 l	330,2 x 431,8 mm





# Spare Parts and Accessories for Spinner Flasks

## Stainless Steel Port Assembly for Angled Side-arm Spinner Flasks

- Seam welded with electropolished finish inside and out (RA32 $\mu$ )
- 2-port with siphon and vent tubes
- 3-port with siphon, fill and vent tubes
- Includes 45 mm PP cap and white silicone gasket



### 2-port with siphon and vent tube for 45° angled GL45 side-arm

Cat. No.	Flask Size	Longest Tube Length
1965-20005R*	500 ml	38,1 mm
1965-21005R**	500 ml	63,5 mm
1965-20001R	1.000 ml	63,5 mm
1965-20003R	3.000 ml	127,0 mm
1965-20006R	6.000 ml	266,7 mm
1965-20008R	8.000 ml	276,2 mm
1965-20015R	15.000 ml	301,6 mm
1965-20036R	36.000 ml	304,8 mm

### 3-port with siphon, fill and vent tubes for 45° angled GL45 side-arm

Cat. No.	Flask Size	Longest Tube Length
1965-30005R*	500 ml	38,1 mm
1965-31005R**	500 ml	63,5 mm
1965-30001R	1.000 ml	63,5 mm
1965-30003R	3.000 ml	127,0 mm
1965-30006R	6.000 ml	266,7 mm
1965-30008R	8.000 ml	276,2 mm
1965-30015R	15.000 ml	301,6 mm
1965-30036R	36.000 ml	304,8 mm

Open Top Caps and Gaskets see page 10

\* 500 ml with 100 mm cap and short width paddle

\*\* 500 ml with 70 mm cap



## 2 Port Sparger Assembly for Angled GL45 Side-arm Spinner Flask

- 12 mm OD coarse glass frit (40-60  $\mu$ m) gently introduces bubbles into vessel
- 0,2  $\mu$ m Acrodisc filter with hose fitting
- Includes GL45 blue PP cap and white silicone gasket

Cat. No.	Flask Size	Longest Tube Length
1965-45003R	3.000 ml	203,0 mm
1965-45006R	6.000 ml, 8.000 ml, 15.000 ml	330,0 mm
1965-45036R	36.000 ml	356,0 mm
1964-12922 T1610	0,2 $\mu$ m Acrodisc filter, 50 mm, box of 8 Glass frit, coarse porosity	



## Port Assemblies, BioSimplex™, Sterile, with Flex-Joint, for GL45 Caps

- To be used for Angled Side-arm Flasks with GL45 Caps
- Flex-Joint accommodates angle deviation in side-arms
- External Tubing: Gamma Irradiated C-Flex® 374 clear tubing, FDA and USP Class IV compliant
- Internal Tubing and Inner Flex-Joint: Polypropylene
- Non-toxic, lower gas permeability than silicone tubing
- Temperature range -80 °C to 121 °C; excellent biocompatibility
- Flex-Joint does not lose shape after autoclaving

### 3-port with siphon, fill and vent tubes

Cat. No.	Flask Size	X	Y
BG10-10300	1.000 ml	209,6 mm	175,9 mm
BG10-10301	3.000 ml	260,4 mm	226,7 mm
BG10-10302	8.000 ml	368,3 mm	334,6 mm
BG10-10303	15.000 ml	387,4 mm	353,7 mm
BG10-10304	36.000 ml	425,5 mm	391,8 mm

### 2-port with siphon and vent tube

BG10-10320	1.000 ml	209,6 mm
BG10-10321	3.000 ml	260,4 mm
BG10-10322	8.000 ml	368,3 mm
BG10-10323	15.000 ml	387,4 mm
BG10-10324	36.000 ml	425,5 mm

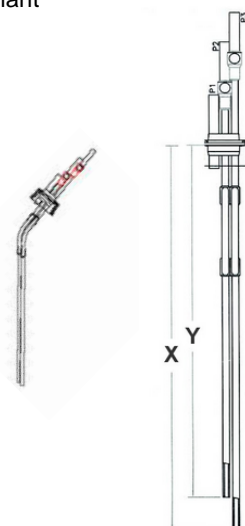

## Universal Port Assemblies for Side-arm Vessels

- Assemblies contain stainless steel sampler, screw cap and silicone liner

Cat. No.	Description
5637-21000R	(a) 2-Port assembly, straight tube, 45 mm
5637-12000R	(b) 2-Port assembly, angled tube, 45 mm
5637-51000	(c) 2-Port assembly, 32 mm*
5637-52000	(d) 2-Port assembly, 32 mm, small ID**
5637-00010	Open Top Cap, 45 mm (box/10)
A523-1156	Open Top Cap, 32 mm
A523-1279	Silicone gasket, white, 32 mm
A523-599	Open Top Cap, 45 mm
A523-600	Silicone gasket, 45 mm

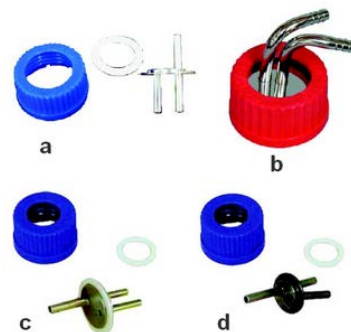

\* Use with 1965-80100, -80250, -97050, -97100, -97300 spinner flasks and 5637-28094 flat bottom vessels

\*\* Use with 1965-10100, -10250, -80100, -80250, -94010, -94025 and 1967-10100, -10250 spinner flasks and 5637-00050, -60050, -70050, -40100 media storage bottles

- Assembly contains PTFE sampler, PP screw cap and silicone gasket

Cat. No.	Description
5637-S0302	2-Port assembly, straight tube, 45 mm



## Screw Caps and Pouring Rings

### Polypropylene Caps, Open Top, with PTFE Faced Silicone Septa, GL32 and GL45

- Autoclavable to 140 °C

Cat. No.	Description	Size	Cs.
5637-00035	(a) Cap, blue, PP	32	10
5637-00038	(b) Septa, 0,3 x 30,5 mm	32	10
5637-00010	(c) Cap, blue, PP	45	10
5637-00015	Cap, green, PP	45	10
5637-00020	Cap, yellow, PP	45	10
5637-00025	Cap, grey, PP	45	10
5637-00030	(d) Septa, 0,3 x 43,2 mm	45	10

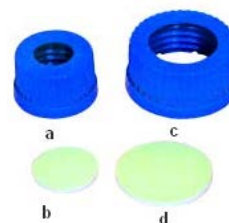

### Polypropylene Caps, Solid, Linerless, with Inner Sealing Lip, GL32 and GL45

- Autoclavable to 140 °C

Cat. No.	Description	Size	Cs.
5637-00032	Solid cap, blue, PP	32	10
5637-00045	Solid cap, blue, PP	45	10
5637-00047	Solid cap, green, PP	45	10
5637-00048	Solid cap, yellow PP	45	10



### High Temperature Polybutyleneterephthalate (PBT) Cap, with PTFE Faced Silicone Liner, GL32 and GL45

- Autoclavable to 200 °C

Cat. No.	Description	Size	Cs.
5637-90032	Solid cap, red, PBT	32	10
5637-90045	Solid cap, red, PBT	45	10



### Premium High Temperature TPCh260 Cap, Clear, Silicone liner double-faced with PTFE, GL45

- Manufactured from TPCh260 without colorants or pigments
- Temperature range: -196 °C to +260 °C
- USP class VI, EP and FDA compliant

Cat. No.	Description	Size	Cs.
5637-00040	Caps	45	5



### Membrane Cap, Polypropylene, with 0,2 µm PTFE Membrane, GL45

- Designed with 0,2 µm PTFE sealed-in gas permeable membrane
- Reduces risk of excess internal pressure
- Can be tightened during autoclaving

Cat. No.	Description	Size	Cs.
5637-00046	Membrane Cap, blue, PP	45	5



### Pouring Rings, GL32 and GL45

Cat. No.	Description	Size	Cs.
5637-10032	Pouring Rings, blue, PP	32	10
5637-10045	Pouring Rings, blue, PP	45	10
5637-91032	Pouring Rings, Red, ETFE	32	10
5637-91045	Pouring Rings, Red, ETFE	45	10
5637-00041	Pouring Rings, TPCh260	45	5



More Caps and Closures see pages 14 - 15

# Overhead Drives

## Digital Display and Process Control Overhead Drive Motors

- Speed range: 5 - 150 rpm
- RS485 data port and motion alarm (process control)
- Reverse direction switch
- Easy mounting bracket with 'peg & grommet' design
- Standard models: 2,15 Nm, 30W
- Hi-torque models: 3,62 Nm, 30W

Cat. No.	Description
7774-10230	Digital
7774-20230	Process control
7774-30230	Hi-torque, digital
7774-40230	Hi-torque, process control
9700-10230	Inline power supply, 230 V



## Overhead Drive Adapters

- Connect overhead drive motors to PTFE or SST folding impellers
- 316L stainless steel with Polyester/SST bearings
- Two 6,5 mm (1/4") NPT plugged ports for optional accessories (Cat. No. 7764-70000 only)

Cat. No.	Description
7764-70000	(a) Standard OHD assembly for 100 mm vessels
7764-71000	(b) Heavy duty drive adapter for large flange headplate
7764-74000	(c) Hi-torque drive adapter



**Additional accessories for our bioreactor vessels such as tubes, ports, adapters, heating blankets or controllers upon request.**

# Insect Cell Culture Systems

## Magnetic Stirrer / Spinner Flasks, digital or process control

The Insect Cell Culture Systems consist of a digital display or process controlled Bell-ennium™ 5-place magnetic stirrer and a choice of 3 Litre spinner flasks, microcarrier flasks or IOB flasks. Also included are Bellco port assemblies, a gas blending stand (1-in, 4-out, air) and silicone tubing (6,4 mm ID). The system needs an additional air pump. Acrodisc filters are sold separately.



Cell Culture System with Digital Display Magnetic Stirrer

Cat. No.	Description	Page	Cs.
1965-70230	<b>Digital Stirrer / Microcarrier Spinner Flask includes:</b>		1
7785-D2015	Digital 5-position magnetic stirrer	13	1
1965-03000	3 Litre microcarrier spinner flask, complete	3	4
1965-20003R	2-port assembly	9	4
7803-33000	Gas blending stand: 1-in, 4-out, air		1
7800-10050	Tubing (6,4 mm (1,4") ID, 127 cm length)		1
1965-76230	<b>Digital Stirrer / IOB Spinner Flask includes:</b>		1
7785-D2015	Digital 5-position magnetic stirrer	13	1
1965-61030	3 Litre spinner flask with internal impeller unit, complete	4	4
1965-20003R	2-port assembly	9	4
7803-33000	Gas blending stand: 1-in, 4-out, air		1
7800-10050	Tubing (6,4 mm (1/4") ID, 127 cm length)		1
1965-80230	<b>Process Controlled System</b> , like 1965-70230 but with Process Controlled Magnetic Stirrer (Cat. No. 7785-P2015)	13	1
1965-86230	<b>Process Controlled System</b> , like 1965-76230 but with Process Controlled Magnetic Stirrer (Cat. No. 7785-P2015)	13	1

# Bell-ennium™ Magnetic Stirrers

**Bell-ennium™ Magnetic Stirrers offer the researcher a wide range of capabilities.** All models feature brushless maintenance-free DC motors and drive assemblies designed for quiet operation. Durable stainless steel covers are stamped to show the magnetic position for accurate vessel placement. Heavy-duty magnet assemblies provide the optimum in magnetic coupling. Timing belts are used on all positions to ensure smooth even stirring of vessel's contents. Both the digital display and the process controller models feature easy-to-read numeric displays.

Electrical specifications for all models: 230 V / 1,5 Amp. power supply

Features	Digital Display	Process-Controlled
Brushless Motor and Motor Controller	✓	✓
In Line Power Supply	✓	✓
Low Profile Aluminum Chassis	✓	✓
On/Off Rocker Switch	✓	✓
Stainless Steel Cover	✓	✓
Non-slip Timing Belts	✓	✓
Heavy Duty Magnetic Drive Plate	✓	✓
Digital RPM Display	✓	✓
Optional Motion Alarm (Factory Installed Only)	✓	✓
Process Controller	-	✓
RS 485 Data Port (monitoring and control)	-	✓
Motion Alarm Port / Alarm jack (non-monitoring)	-	✓

## One Position Magnetic Stirrers

Speed range: 30 - 500 rpm  
 Dimensions (wxdxh): 8 l: 25 x 28 x 8,5 cm  
 36 l: 45 x 51 x 8,5 cm  
 Weight: 8 l: 4 kg  
 36 l: 7,5 kg  
 Maximum Flask Size: 1 x 8 l / 1 x 36 l

Cat. No.	Description
7785-D1208	One position, digital, for 1 x 8 l flask
7785-P1208	One position, process control, for 1x 8 l flask
7785-D1236	One position, digital, for 1 x 36 l flask



## Two Position Magnetic Stirrers

Speed range: 30 - 500 rpm  
 Dimensions (wxdxh): 51 x 28 x 8,5 cm  
 Weight: 5,5 kg  
 Maximum Flask Size: 2 x 8 l

7785-D1512	Two position, digital
7785-P1512	Two position, process controlled



## Two Position Magnetic Stirrers with End Panel Controls

(Due to its design with the control panel at the small head side this stirrer is a real space saver. Your choice to place two or three stirrers with differing speeds in your CO<sub>2</sub> incubator)

Specifications like the 2-position magnetic stirrers  
 Dimensions (wxdxh): 28 x 51 x 8,5 cm

7785-D1532	Two position, digital
7785-P1532	Two position, process controlled



## Five Position Magnetic Stirrers

Speed range: 30-500 rpm  
Dimensions (wxdxh): 41 x 45 x 7,5 cm, (compact: 37 x 38 x 7,5 cm)  
Weight: 8,2 kg  
Maximum Flask Size: 5 x 1 Litre or 4 x 3 Litre,  
(compact 5 x 0,5 or 4 x 1 Litre)

Cat. No.	Description
7785-D2015	Five position, digital
7785-D5015	Five position, digital, compact
7785-P2015	Five position, process control
7785-P5015	Five position, process control, compact



## Nine Position Magnetic Stirrers

Speed range: 30-500 rpm  
Dimensions (wxdxh): 42 x 45 x 8,5 cm  
Weight: 9 kg  
Maximum Flask Size: 9 x 500 ml (70 mm central cap)

Cat. No.	Description
7785-D9015	Nine position, digital
7785-P9015	Nine position, process control



## Bell-ennium™ Optional Motion Alarm for Magnetic Stirrers (factory installed only)

7785-11111 Optional motion alarm, digital display  
7785-22222 Optional motion alarm, process control

All models can be customized for higher or lower speeds. Contact us for detailed information.

## Bell-Stir Magnetic Stirrers

Designed for mammalian and bacterial cultures grown in spinner flasks

Speed range: 30-1000 rpm  
Dimensions (wxdxh): 16 x 16 x 13 cm, 1-position, 1 Litre  
26 x 26 x 13 cm, 1-position, 8 Litre

Cat. No.	Description
7760-06220	1-position magnetic stirrer, 1 Litre
7760-06223	1-position magnetic stirrer, 8 Litre



## Mini Tube Roller

- Accommodates various bottle dimensions by removing idler rollers
- For tubes and bottles with an OD from 1,6 - 12 cm
- 6 Drive rollers and 5 idler rollers

Speed range: 0,1 - 30 rpm (depending on bottle/tube OD)  
Dimensions (wxdxh): 38 x 48 x 8 cm  
Maximum Bottle Length: 25,4 cm  
Maximum Load: 4,5 kg

Cat. No.	Description
7622-30230	Mini Tube Roller



→ Further Tube Rollers in our programme: please enquire!

# Products for Cell Culture

## Stainless Steel Port Assembly for GL45 Media Bottles

- Seam welded with electropolished finish inside and out RA32 $\mu$
- 2-port with siphon and vent tubes
- 3-port with siphon, fill and vent tubes
- 6,35 mm (1/4") OD tubing
- Includes 45 mm PP screw cap and white silicone gasket

### 2-port with siphon and vent tube

Cat. No.	Flask size	Cs.
5637-20001R	1 l	1
5637-20002R	2 l	1
5637-20005R	5 l	1
5637-20010R	10 l	1

### 3-port with siphon, fill and vent tubes

Cat. No.	Flask size	Cs.
5637-30001R	1 l	1
5637-30002R	2 l	1
5637-30005R	5 l	1
5637-30010R	10 l	1

A523-599	Cap, 45 mm	1
A523-600	Silicone gasket	1

Port assemblies for media bottles with BioSimplex™ tubing available on request.



## Black Phenolic Screw Caps (Bakelite) with Liner

- Screw caps with white rubber or PTFE bonded liner
- Long cap design to reduce risk of cross-contamination
- Autoclavable

Cat. No.	Thread	Cap design	Liner	Cs.
2029-00013	13-415	long	White rubber	144
2029-00016	15-415	long	White rubber	144
2029-00018	18-415	long	White rubber	144
2029-00025	24-415	long	White rubber	144
2029-00028	28-415	long	White rubber	72
2029-00038	38-415	long	White rubber	36
2030-00038	38-415	long	PTFE/bonded	72
2029-00051	51-400	short	White rubber	72
7730-00038	38-400	short	White rubber	36



## Silicone Sponge Closures

- Sealed-in silicone sponge filter is ideal for aerobic cultures
- Flanged to fit snugly over outside of vessel neck preventing passage of aerosols
- Closures will withstand autoclaving and dry heat sterilization (180 °C)

Cat. No.	Suitable for	Size (mm)	Cs.
2004-00002	13 - 18 mm Culture tubes 18 mm screw necks	13-18	10
2004-00003	18 - 25 mm Culture tubes 25 - 50 ml Erlenmeyer flasks 25 - 125 ml DeLong® flasks	20-25	10
2004-00004	125 - 300 ml Erlenmeyer flasks	28	10
2004-00005	38 mm Culture tubes 500 - 1000 ml Erlenmeyer flasks 250 - 6000 ml DeLong® flasks For over 45 mm screw necks	38	10



## Silicone Sponge Plug Closures

- Tapered silicone sponge with smooth exterior for tight seal
- Extra long for easy insertion and removal

Cat. No.	Description	Size (mm)	Cs.
1924-00032	For 25 mm culture tubes and 32 mm side-arms	32	25



## Stainless Steel Closures

- For aerobic culture in tubes and flasks utilizing DeLong® Necks
- Made from 305 stainless steel (prevents corrosion)
- With finger grips for firm fit on the flask
- Suitable for dry heat sterilization and repeated autoclaving

Cat. No.	Tube OD	Cs.
2005-00013A	13 mm	144
2005-00016	16 mm	144
2005-00018	18 mm	144
2005-01824	18 mm	24
2005-00020	20 mm	144
2005-00025	25 mm	72
2005-02512	25 mm	12
2005-00038	38 mm	36
2005-03803	38 mm	3
2005-03806	38 mm	6
2005-03812	38 mm	12



## KAP-UTS™ Disposable Closures

- For culture tubes and flasks with DeLong® style necks and access ports
- Manufactured from nontoxic autoclavable Polypropylene
- Seven colours for easy identification
- Six sizes from 13 mm to 38 mm
- Same evaporation and sterility characteristics as stainless steel closures
- Molded pressure fins for firm grip
- Autoclavable to 140 °C

Cat. No.	Size	Colour	Cs.
2007-13001	13 mm	black	1000
2007-13002	13 mm	red	1000
2007-13003	13 mm	yellow	1000
2007-13004	13 mm	blue	1000
2007-13005	13 mm	white	1000
2007-13006	13 mm	green	1000
2007-16001	16 mm	black	1000
2007-16002	16 mm	red	1000
2007-16003	16 mm	yellow	1000
2007-16004	16 mm	blue	1000
2007-16005	16 mm	white	1000
2007-16006	16 mm	green	1000
2007-18001	18 mm	black	1000
2007-18002	18 mm	red	1000
2007-18003	18 mm	yellow	1000
2007-18004	18 mm	blue	1000
2007-18005	18 mm	white	1000
2007-18006	18 mm	green	1000
2007-20001	20 mm	black	500
2007-20002	20 mm	red	500
2007-20003	20 mm	yellow	500
2007-20004	20 mm	blue	500
2007-20005	20 mm	white	500
2007-20006	20 mm	green	500
2007-25001	25 mm	black	500
2007-25002	25 mm	red	500
2007-25003	25 mm	yellow	500
2007-25004	25 mm	blue	500
2007-25005	25 mm	white	500
2007-25006	25 mm	green	500
2007-25013	25 mm	colourless	500
2007-38005	38 mm	white	250



## Aseptic Filling Bell

- Attaches to reservoir with rubber tubing
- Receiving vessel is placed under the bell
- Type 1 Class A Borosilicate Glass



Cat. No.	ID / Height	Tubing Size	Cs.
5610-00020*	22 mm / 75 mm	1/4" / 0,64 cm	2
5610-00040*	41 mm / 95 mm	1/4" / 0,64 cm	2
5610-00050*	49 mm / 100 mm	1/2" / 1,27 cm	2
5610-00070**	70 mm / 125 mm	1/2" / 1,27 cm	2
5610-00100**	104 mm / 130 mm	1/2" / 1,27 cm	2

\* For use with tubes, \*\*For use with bottles

## Cloning Cylinders, Borosilicate Glass\*

- Surrounds single cell to create homogenous culture of cells rather than mixed population
- Flat end assures tight sealing with the surface of culture dish

Cat. No.	OD	Height	Cs.
2090-00608	6 mm	8 mm	125
2090-00808	8 mm	8 mm	125
2090-01010^	10 mm	10 mm	125
2090-S0022^	16 mm	10 mm	1

\*Also available in stainless steel and other sizes on request.

^ Requires 15 mm deep petri dish

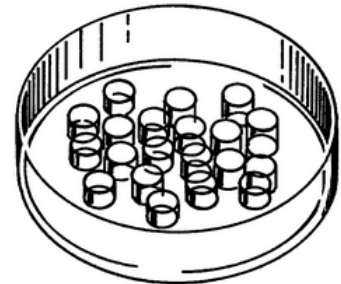

## Disinfectant Testing Glazed Cylinder, Borosilicate Glass

- For use in the disinfectant testing procedure as described in the AOAC manual
- Cylinder ends are lightly glazed

Ref: Rubino et al. (1992), Hard Surface Carrier Test for Efficacy Testing of Disinfectants.

Cat. No.	OD	Height	Cs.
2091-00808	8 mm	8 mm	125
2091-08010^	8 mm	10 mm	125

^ Requires 15 mm deep petri dish



## Products for Chromatography and Biotechnology

HPLC and Autosampler Vials and Closures with Screw Thread, Crimp Top, or Snap Seal

96-Well Multi-Tier Micro Plate System

More information on request!



Design, Engineering and Manufacturing



# Cover Slips and Microscope Slides

## Rectangular and Square Cover Slips

- Manufactured from Schott D263 glass ("German Glass") for fluorescence and confocal microscopy
- Glass thickness: 0,13 mm - 0,16 mm (# 1)

Cat. No.	Size	approx./cs.
1916-09009A*	9 x 9 mm	100
1916-09022*	9 x 22 mm	200
1916-09035A*	9 x 35 mm	100
1916-09050A*	9 x 50 mm	100
1916-10522A*	10.5 x 22 mm	100
1916-10535A*	10.5 x 35 mm	100
1916-10550A*	10.5 x 50 mm	100
1916-13054A*	13 x 54 mm	100
1916-12222A	22 x 22 mm	100
1916-24050A	24 x 50 mm	100
1916-25075	25 x 75 mm	100



\* For use with Bellco Leighton Tissue Culture Tubes (page 28).

## Round Cover Slips

- Manufactured from Schott D263 glass ("German Glass") for fluorescence and confocal microscopy
- Glass thickness: 0,13 mm - 0,16 mm (# 1)
- Ideal for neural tissue culture and hard-to-attach cells
- Specially developed for fluorescence and confocal microscopy with very low background fluorescence

Cat. No.	Diameter	approx./cs.
1943-00005	5 mm	100
1943-10012A	12 mm	100
1943-10015A	15 mm	100
1943-10025A	25 mm	100



## Photo-etched Cover Slips

- Coding facilitates micromanipulation of cells or analysis of chromosome spreads
- Manufactured from Schott D263 glass ("German Glass") for fluorescence and confocal microscopy
- Coded area each square: 0,6 x 0,6 mm
- Glass thickness:  
square: 0,19 mm - 0,25 mm (#1,5)  
round: 0,13 mm - 0,16 mm (# 1)

References: Lin, Pin-Fang and Frank H. Riddle 1981.  
Photoengraving of Cover Slips and Slides  
to Facilitate Mounting of Micromanipulated Cells  
or Chromosome Spreads, Exp. Res. 134:485-488

Cat. No.	Size	Squares	Unit
1916-91818	square, 18 x 18 mm	520	25
1916-92525	square, 23 x 23 mm	520	25
1916-91012	round, 12 mm	100	25
1916-91025	round, 25 mm	200	25
1943-70000	Vacuum Pick-up Tool, facilitates the handling of coverslips		1

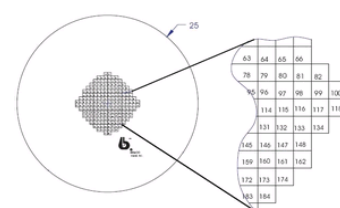
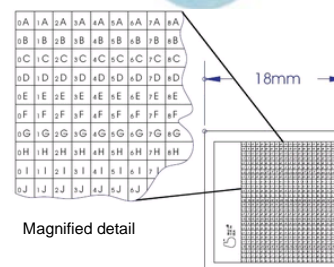

Magnified detail

## Pre-cleaned Plain Microscope Slides

- Square corners and ground edges
- Extra white clear soda-lime glass
- No frosted ends

Cat. No.	Size	Thickness	Cs.
5638-11013	25 x 75 mm	0,90 - 1,09 mm	1440
5638-12013	25 x 75 mm	1,10 - 1,30 mm	1440



## Frosted Microscope Slides

- Slide with two 10 x 10 mm photo etched areas with 1,5 x 1,5 mm squares
- Available with either one or both ends frosted

Cat. No.	Size	Thickness	Cs.
5638-10300A	25 x 75 mm	0,90 - 1,09 mm	50

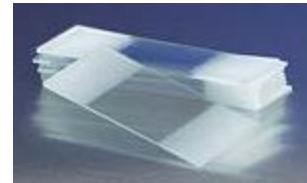

## Reich Counting Slide

- Spreading a known volume of solution over a known area permits a calculation of bacteria per sample
- Three rings with each interior area measuring 1 cm<sup>2</sup>

Cat. No.	Description	Thickness	Cs.
5638-01920	Reich slide	25 x 75 mm	144



## Somatic Cell Counting Slide

- For direct microscopic counts of somatic cells in cow's milk
- Spread 0,01 ml sample onto each circle and then dry and stain
- Count cells under oil immersion lens

Cat. No.	Description	Thickness	Cs.
5638-01930	Somatic cell slide	25 x 75 mm	144



## Fluorescent Antibody Slide

- For indirect fluorescent antibody test including test for toxoplasmosis
- Black ceramic background with eight rings (6 mm diameter)

Cat. No.	Description	Thickness	Cs.
5638-01940	Fluorescent antibody slide	25 x 75 mm	144



## Sykes-Moore Chamber\*

For the study of cells by means of high magnification, phase optics, or time lapse techniques.

Designed for stationary culture with intermittently exchanged media. Cover slips are separated and an internal seal is maintained by a nontoxic, silicone gasket. The chamber has a 2,8 cm<sup>2</sup> viewing area and holds approximately 0,65 to 0,75 ml.

Cat. No.	Description	Cs.
1943-11111	Sykes-Moore Chamber (a)	1
1943-20002	Cover slips Ø 25 mm (thickness #2) (b)	100
1943-10025A	Cover slips Ø 25 mm (thickness #1) (b)	100
1943-33315	Silicone gasket for 1,5 mm gap (c)	6
1943-33325	Silicone gasket for 2,5 mm gap	6
1943-44444	Wrench	1
1943-55555	Metal frame for use in the microscope	1

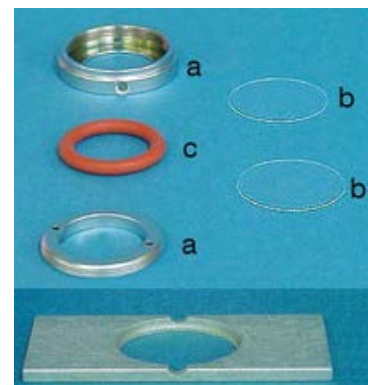

\* Ref.: Sykes, J.A. and E.B. Moore. 1959. A New Chamber for Tissue Culture. Proc. Soc. for Exp. Biol. and Med. 100:121-127  
 Sykes, J.A. and E.B. Moore. 1960. A Simple Tissue Culture Chamber. Texas Report on Biol. and Med. 18(2):288-297



## Multispot Microscope Slides

for Immunofluorescence Test and Cell Culture

- 8, 10, 12 or 15 spots, various diameters
- Self-draining surface & heat resistant
- Custom designs possible.

More information on request!

# Flasks and Bottles

## Roux Bottles

- When laid down flat, it will hold approximately half the total volume.
- The offset neck prevents cultures from entering the neck area
- With screw thread or DeLong® Neck

Cat. No.	Description	Cs.
5630-12000	<b>DeLong® Neck</b> , Volume 1200 ml, includes SST closures (38 mm)	2
2005-03803	38 mm SST closures (see page 15)	3
5632-12000	<b>Screw Thread</b> , Volume 1200 ml, includes phenolic 38-415 rubber lined caps	2
2029-00038	38-415 rubber lined phenolic cap (Bakelite) (see page 14)	36



## Shake Flasks

- For preliminary fermentation and bacterial growth studies
- From Typ1 Class A Borosilicate Glass
- Designed for use with SST closures, KAP-UTS™ or silicone sponge closures (see pages 14 - 15)
- Flasks and closures autoclavable

### DeLong® Style Neck with Stainless Steel Closures, without Baffles

- Graduated to approximate volumes

Cat. No.	Capacity (ml)	Closures (mm)	Ø x Height (mm)	Cs.
2510-00025	25	18	40 x 96	24
2510-00050	50	18	50 x 105	24
2510-00125	125	25	66 x 136	12
2510-00250	250	38	80 x 160	12
2510-00300	300	38	88 x 170	12
2510-00500	500	38	100 x 205	12
2510-01000	1000	38	128 x 235	6
2510-02000	2000	38	158 x 295	3
2510-03000	3000	38	184 x 340	3
2510-04000	4000	38	205 x 370	3
2510-06000	6000	38	235 x 410	3



### DeLong® Style Neck without Stainless Steel Closures, without Baffles

- Graduated to approximate volumes

Cat. No.	Capacity (ml)	Closures (mm)	Ø x Height (mm)	Cs.
2511-00025	25	18	40 x 96	24
2511-00050	50	18	50 x 105	24
2511-00125	125	25	66 x 136	12
2511-00250	250	38	80 x 160	12
2511-00300	300	38	88 x 170	12
2511-00500	500	38	100 x 205	12
2511-01000	1000	38	128 x 235	6
2511-02000	2000	38	158 x 295	3
2511-04000	4000	38	205 x 370	3
2511-06000	6000	38	235 x 410	3



### DeLong® Style Neck, four Extra Deep Bottom Baffles, with Constriction

Cat. No.	Capacity (ml)	Closures (mm)	Ø x Height (mm)	Cs.
2547-00250	250	38	81 x 160	12
2547-00500	500	38	100 x 203	12
2547-01000	1000	38	128 x 235	6



### DeLong® Style Neck, three Side Baffles

Cat. No.	Capacity (ml)	Closures (mm)	Ø x Height (mm)	Cs.
2540-00050	50	18	50 x 105	12
2540-00125	125	25	66 x 136	12
2540-00250	250	38	80 x 160	12
2540-00300	300	38	88 x 170	12
2540-00500	500	38	100 x 205	12
2540-01000	1000	38	128 x 235	6
2540-02000	2000	38	158 x 290	3



### Break-Resistant Lip, three Side Baffles

Cat. No.	Capacity (ml)	Ø x Height (mm)	Cs.
2541-00125	125	66 x 116	12
2541-00250	250	80 x 140	12
2541-01000	1000	128 x 220	6
2541-02000	2000	158 x 290	3



### Break-Resistant Lip, three Extra Deep Side Baffles

Cat. No.	Capacity (ml)	Ø x Height (mm)	Cs.
2542-00250	250	80 x 140	12
2542-00300	300	88 x 150	12
2542-00500	500	100 x 183	12
2542-01000	1000	128 x 220	6
2542-02000	2000	158 x 290	3



### DeLong® Style Neck, three Extra Deep Side Baffles

Cat. No.	Capacity (ml)	Closures (mm)	Ø x Height (mm)	Cs.
2543-00050	50	18	50 x 105	12
2543-00125	125	25	66 x 136	12
2543-00250	250	38	80 x 160	12
2543-00300	300	38	88 x 170	12
2543-00500	500	38	100 x 205	12
2543-01000	1000	38	128 x 235	6
2543-02000	2000	38	158 x 295	3
2543-03000	3000	38	184 x 340	3
2543-04000	4000	38	205 x 370	3



### DeLong® Style Neck, six Baffles

- With three Bottom Baffles, or three Bottom and three Side Baffles

Cat. No.	Capacity (ml)	Closures (mm)	Ø x Height (mm)	Cs.
2543-60250	250	38	80 x 160	12
2543-60500	500	38	100 x 205	12
2543-61000	1000	38	128 x 235	6
2543-62000	2000	38	158 x 295	3
2543-63000	3000	38	184 x 340	3
2543-64000	4000	38	205 x 370	3

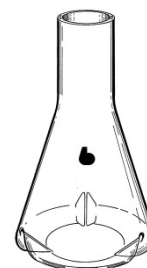

### Wide Mouth with GL45 PP Membrane Screw Cap and Pouring Ring

- 45 mm Polypropylene Screw Cap with 0,2 µm PTFE Membrane (5637-00046 / page 10)
- With three Bottom Baffles, or three Bottom and three Side Baffles

Cat. No.	Capacity (ml)	Closures (mm)	Ø x Height (mm)	Cs.
2545-00250	250	45	80 x 117	12
2545-00500	500	45	100 x 156	12
2545-01000	1000	45	128 x 200	6
2545-02000	2000	45	158 x 260	3



## Erlenmeyer Flasks

- For general laboratory use such as media preparation, storage and cultivation of microorganisms
- From Typ1 Class A Borosilicate Glass
- Graduated to approximate volumes

### Narrow Mouth with Break-Resistant Lip

Cat. No.	Capacity (ml)	Stopper Size	Ø x Height (mm)	Cs.
2504-00025	25	0	39 x 66	24
2504-00050	50	1	50 x 80	24
2504-00125	125	5	66 x 115	12
2504-00250	250	6	80 x 140	12
2504-00300	300	6	88 x 148	12
2504-00500	500	7	100 x 183	12
2504-01000	1000	9	128 x 223	6
2504-02000	2000	10	158 x 290	3
2504-03000	3000	10	184 x 305	3
2504-04000	4000	10	205 x 355	3
2504-06000	6000	10	237 x 395	3



### Narrow Mouth with Heavy Duty Rim, Academic Line

Cat. No.	Capacity (ml)	Stopper Size	Ø x Height (mm)	Cs.
2505-00100	100	5	64 x 105	12
2505-00300	300	6	87 x 156	12
2505-00500	500	7	105 x 180	6
2505-01000	1000	9	131 x 220	6



### Narrow Mouth with Phenolic Rubber Lined Screw Cap

- Long-skirted screw caps protect against contamination (see page 14)

Cat. No.	Capacity (ml)	Cap (mm)	Ø x Height (mm)	Cs.
2514-00025	25	18-415	40 x 65	24
2514-00050	50	24-415	50 x 85	24
2514-00125	125	24-415	66 x 125	12
2514-00250	250	38-415	80 x 143	12
2514-00300	300	38-415	88 x 150	12
2514-00500	500	38-415	100 x 190	12
2514-01000	1000	38-415	128 x 220	6
2514-02000	2000	38-415	158 x 275	3
2514-03000	3000	38-415	184 x 320	3
2514-04000	4000	38-415	205 x 350	3
2514-06000	6000	38-415	235 x 390	3



### Wide Mouth with GL45 Screw Cap and Pouring Ring

- With 45 mm Polypropylene Linerless Screw Cap and Pouring Ring

Cat. No.	Capacity (ml)	Cap (mm)	Ø x Height (mm)	Cs.
2515-00250	250	45	80 x 117	12
2515-00500	500	45	100 x 156	12
2515-01000	1000	45	128 x 200	6
2515-02000	2000	45	158 x 260	3
2515-04000	4000	45	205 x 325	1
2515-06000	6000	45	235 x 370	1



## Fernbach Flasks from Borosilicate Glass

- For culturing organism requiring a large surface to volume ratio
- From Typ1 Class A Borosilicate Glass
- Designed for use with SST closures, KAP-UTS™ or silicone sponge closures (see page 14-15)
- Flasks and closures autoclavable

### DeLong® Style Neck, Ø 38 mm

- Without Baffles

Cat. No.	Capacity (ml)	Ø x Height (mm)	Cs.
2550-01800	1800	200 x 175	3
2550-02800	2800	205 x 250	3



### Wide Mouth with Break-Resistant Lip

- With three Side Baffles

Cat. No.	Capacity (ml) and Description	Ø x Height (mm)	Cs.
2551-01800	1800, 3 Side Baffles	200 x 157	3
2551-02800	2800, 3 Side Baffles	210 x 225	3



### DeLong® Style Neck, Ø 38 mm

- With three Bottom Baffles, or three Bottom and three Side Baffles

Cat. No.	Capacity (ml) and Description	Ø x Height (mm)	Cs.
2554-01800	1800, 3 Bottom Baffles	200 x 175	3
2554-02800	2800, 3 Bottom Baffles	210 x 250	3
2554-02833	2800, 6 Baffles	200 x 250	3



### Wide Mouth with GL45 Screw Cap and Pouring Ring

- 45 mm Polypropylene Screw Cap
- With three Bottom Baffles, or three Bottom and three Side Baffles

Cat. No.	Capacity (ml) and Description	Ø x Height (mm)	Cs.
2552-01800	1800, 3 Bottom Baffles	200 x 157	1
2552-02800	2800, 3 Bottom Baffles	210 x 225	1
2552-02833	2800, 6 Baffles	210 x 225	1



### Wide Mouth with GL45 Membrane Screw Cap and Pouring Ring

- 45 mm Polypropylene Screw Cap with 0,2 µm PTFE Membrane
- With three Bottom Baffles, or three Bottom and three Side Baffles

Cat. No.	Capacity (ml) and Description	Ø x Height (mm)	Cs.
2552-18000	1800, no Baffles	200 x 157	1
2552-28000	2800, no Baffles	210 x 225	1
2552-01803	1800, 3 Bottom Baffles	200 x 157	1
2552-02803	2800, 3 Bottom Baffles	210 x 225	1
2552-62180	1800 ml, 6 Baffles	200 x 157	1
2552-62280	2800 ml, 6 Baffles	210 x 225	1
5637-00046	GL45, Polypropylene, 0,2 µm PTFE Membrane Cap		5



## Anaerobic Culture Bottles and Caps

- Type 1 Class A Borosilicate Glass
- GL45 PP screw cap, including silicone o-ring and blue butyl rubber septum stopper for maintaining anaerobic conditions during sample harvesting

Cat. No.	Capacity (ml)	Cs.
2048-50100	100	12
2048-50250	250	12
2048-50500	500	6
2048-51000	1000	6
2048-50000	Anaerobic cap with silicone o-ring and 1 septum stopper	1
2048-11800A	Replacement septum stoppers	100



## Trypsinizing Flask with 3 Deep Side Baffles and 15-415 Screw Thread Side-arm

- Type 1 Class A Borosilicate Glass
- Promotes enzymatic digestion of tissue fragments and homogenates into cell suspensions
- Designed with deep side baffles for optimal agitation
- Dam below side-arm for retention of undissociated material
- Graduated to approximate volumes
- Includes rubber lined, black phenolic screw caps

Cat. No.	Capacity (ml)	Centre Cap	Ø x Height (mm)	Cs.
1989-00125	125	25-415	66 x 135	3
1989-00250	250	38-415	80 x 163	3
1989-00500	500	38-415	100 x 190	3

Replacement caps available, see page 14



## Trypsinizing Flask with 3 Deep Side Baffles and Break-Resistant Lip

- Type 1 Class A Borosilicate Glass
- Designed with deep side baffles for optimal agitation

Cat. No.	Capacity (ml)	Ø x Height (mm)	Cs.
1992-00050	50	50 x 80	3
1992-00125	125	66 x 115	3
1992-00250	250	80 x 140	3
1992-00500	500	100 x 183	3
1992-01000	1000	128 x 233	2
1992-02000	2000	158 x 290	2
1992-04000	4000	205 x 360	2



## Biometer Flask

- Measure microbial CO<sub>2</sub> production for prolonged periods of time
- Ideal for bioremediation studies
- Acids and bases can be induced through the delivery funnel and gas is collected in the second chamber to be removed with a syringe connected to the luer lock on the needle
- Type 1 Class A Borosilicate Glass
- All components are autoclavable

Cat. No.	Description	Cs.
2556-00250	Biometer flask, 250 ml, complete contains flask, delivery funnel, needle and two stoppers	1
2556-10250	Biometer flask, 250 ml, with stoppers only	1
2556-20250	Delivery funnel with stopper	1
2556-30250	Needle with stopper	1



## Nephelo Culture Flasks

- Type 1 Class A Borosilicate Glass
- For closures see pages 14 - 15

### DeLong® Style Neck, Ø 25 mm, with SST closure

Cat. No.	Capacity	Side-arm Ø x Length	Cs.
2571-14130	125 ml	14 mm x 130 mm	4
2571-14133	300 ml	14 mm x 130 mm	4



### Cleanout Port, including Phenolic Rubber Lined Screw Caps

- Central 38-415 screw thread, side-arm 18-415 screw thread

Cat. No.	Capacity	Side-arm Ø x Length	Cs.
2574-12133	300 ml	12 mm x 130 mm	4
2574-14133	300 ml	14 mm x 130 mm	4
2574-19133	300 ml	19 mm x 130 mm	4
2574-12135	500 ml	12 mm x 130 mm	4
2574-14135	500 ml	14 mm x 130 mm	4
2574-19135	500 ml	19 mm x 130 mm	4
2574-12131	1,000 ml	12 mm x 130 mm	4
2574-14131	1,000 ml	14 mm x 130 mm	4
2574-19131	1,000 ml	19 mm x 130 mm	4



### DeLong® Style Neck, Ø 25 mm, with 3 Bottom Baffles, with SST closure

Cat. No.	Capacity	Side-arm Ø x Length	Cs.
2578-12133	300 ml	12 mm x 130 mm	4
2578-14133	300 ml	14 mm x 130 mm	4
2578-19133	300 ml	19 mm x 130 mm	4



### Cleanout Port, with 3 Bottom Baffles, including Phenolic Rubber Lined Screw Caps

- Central 38-415 screw thread, side-arm 18-415 screw thread

Cat. No.	Capacity	Side-arm Ø x Length	Cs.
2581-14133	300 ml	14 mm x 130 mm	4
2581-19133	300 ml	19 mm x 130 mm	4
2581-14135	500 ml	14 mm x 130 mm	4
2581-19135	500 ml	19 mm x 130 mm	4



## Volumetric Flasks

- Type 1 Class A Borosilicate Glass
- Meets ASTM E288 specifications
- Permanent graduation line and marking area
- Clear glass or amber stained glass for light sensitive materials

Cat. No.	Glass	Capacity	Stopper Size	Cs.
2525-00010	Clear	10 ml	9	6
2525-00025	Clear	25 ml	9	6
2525-00050	Clear	50 ml	13	4
2525-00100	Clear	100 ml	13	4
2525-00200	Clear	200 ml	16	4
2525-00250	Clear	250 ml	16	4
2525-00500	Clear	500 ml	19	2
2525-01000	Clear	1,000 ml	22	2
2525-02000	Clear	2,000 ml	27	2
2526-00010	Amber	10 ml	9	6
2526-00025	Amber	25 ml	9	6
2526-00050	Amber	50 ml	13	4
2526-00100	Amber	100 ml	13	4
2526-00200	Amber	200 ml	16	4



**NEW! - Also available: A large choice of Bellco "Bioprocess" Plastic and Glass Labware for Filtration, Fluid Management and Lab Safety. Please feel free to contact us.**



# Homogenizers

## Dounce Tissue Homogenizer with Glass Tube and Pestle

- Designed for disruption of whole cells leaving cell nuclei undamaged
- Polished tube and pestles
- Two pestles supplied with each unit:  
Large clearance pestle A for initial sample processing,  
Small clearance pestle B completes homogenization

Cat. No.	Capacity	Large pestle A clearance	Small pestle B clearance	Tube OAL
1984-10002	2 ml	76,2 - 127,0 $\mu\text{m}$	12,7 - 63,5 $\mu\text{m}$	60 mm
1984-10007	7 ml	71,1 - 119,4 $\mu\text{m}$	20,3 - 55,9 $\mu\text{m}$	125 mm
1984-10015	15 ml	88,9 - 165,1 $\mu\text{m}$	25,4 - 76,2 $\mu\text{m}$	157 mm
1984-10040	40 ml	76,2 - 152,4 $\mu\text{m}$	25,4 - 76,2 $\mu\text{m}$	215 mm
1984-10100	100 ml	50,8 - 254,0 $\mu\text{m}$	12,7 - 139,7 $\mu\text{m}$	232 mm



## Potter-Elvehjem Tissue Homogenizer, Ground Glass Tube and Pestle

- Clearance between pestle and tube is 0,1 to 0,15 mm
- Suitable for processing of tougher tissues such as connective tissue

Cat. No.	Capacity	Pestle OAL x Shaft $\varnothing$	Tube OAL x Reservoir $\varnothing$
1983-10019	1 ml	145 x 5 mm	95 x 13 mm
1983-10021	5 ml	205 x 6 mm	140 x 16 mm
1983-10022	8 ml	215 x 8 mm	150 x 18 mm
1983-10023	17 ml	265 x 10 mm	175 x 25 mm
1983-10024	45 ml	315 x 10 mm	220 x 32 mm



## Potter-Elvehjem Tissue Homogenizer, Unground Glass Tube and PTFE Pestle

- Sizes 5 ml to 45 ml have radial serrations on the lower portion of the pestle
- Clearance between pestle and tube is 0,1 to 0,15 mm
- Suitable for softer tissue such as brain and liver

Cat. No.	Capacity	Pestle-OAL x Shaft $\varnothing$	Tube OAL x Reservoir $\varnothing$
1983-20018	0,5 ml	130 x 3 mm	80 x 12 mm
1983-20021	5 ml	215 x 6 mm	140 x 15 mm
1983-20022	8 ml	212 x 6 mm	150 x 19 mm
1983-20023	17 ml	266 x 6 mm	175 x 25 mm
1983-20024	45 ml	269 x 6 mm	220 x 32 mm



## Conical Homogenizer, Ground Glass Tube and Pestle

- Big surface area for efficient break up
- Clearance between pestle and tube is 0,1 to 0,15 mm
- Ideal for tissues such as skeletal muscle, heart and lung
- Designed for use with homogenizing motor

Cat. No.	Capacity	Pestle-OAL x Shaft $\varnothing$	Tube OAL x Reservoir $\varnothing$
1976-10020	1 ml	155 x 5 mm	80 x 13 mm
1976-10021	3 ml	210 x 6 mm	120 x 16 mm
1976-10022	5 ml	228 x 6 mm	150 x 18 mm
1976-10023	15 ml	268 x 6 mm	175 x 25 mm
1976-10024	30 ml	305 x 10 mm	215 x 32 mm
1976-10025	50 ml	330 x 10 mm	225 x 38 mm

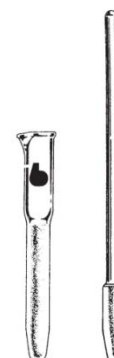

## Tenbroeck Tissue Homogenizer, Ground Glass Tube and Pestle

- Hollow glass pestle allows the addition of ice water for chilling samples during homogenization
- Tooled pestle top for use with rubber stopper (not supplied)
- Clearance between pestle and tube is 0,1 to 0,15 mm

Cat. No.	Capacity / Stopper-No.	Pestle-OAL x Shaft $\varnothing$	Tube OAL x Reservoir $\varnothing$
1982-10002	2 ml / 00	160 x 50 mm	100 x 30 mm
1982-10007	7 ml / 00	195 x 50 mm	125 x 30 mm
1982-10015	15 ml / 1	250 x 65 mm	157 x 38 mm
1982-10040	40 ml / 3	315 x 90 mm	215 x 55 mm



## Homogenizer Overhead Drive

- Permanent magnet motor, for 7,9 mm diameter shafts
- High speed shaft: 4000 rpm
- Low speed shaft: 333 rpm
- Reverse direction switch
- Electronic motor controller

Cat. No.	Description
1981-20230	Homogenizer Overhead Drive
1981-30000	Motor stand
1981-40000	Flex grip chuck for glass 10 mm pestles
1981-50000	Flex grip chuck for glass 6 mm pestles



## Collector™ Tissue Sieve Homogenizer and Mesh Screens

- Prepare cell suspensions and gel extraction of proteins
- All stainless steel construction
- Available with 85 ml or 130 ml pans

Cat. No.	Description	Size	Cs.
1985-85000	Collector complete*	85 ml	1
1985-18500	Collector pan and key	85 ml	1
1985-11516	Glass pestle only	16 mm	1
1985-28500	Collector key only		1
1985-00010	Screen only	10 Mesh / 1910 µm	5
1985-00020	Screen only	20 Mesh / 860 µm	5
1985-00030	Screen only	30 Mesh / 520 µm	5
1985-00040	Screen only	40 Mesh / 380 µm	5
1985-00050	Screen only	50 Mesh / 280 µm	5
1985-00060	Screen only	60 Mesh / 230 µm	5
1985-00080	Screen only	80 Mesh / 190 µm	5
1985-00100	Screen only	100 Mesh / 140 µm	5
1985-00150	Screen only	150 Mesh / 94 µm	5
1985-00200	Screen only	200 Mesh / 74 µm	5
1985-00300	Screen only	300 Mesh / 46 µm	5
1985-00400	Screen only	400 Mesh / 38 µm	5
1985-00500	Screen only	500 Mesh / 25 µm	5



\* Collector™ complete includes: pan, glass pestle, key and nine screens (one each) 10 to 150 mesh size

## BioVortexer Motor, Pestles and Tubes

- Battery powered, hand held tissue homogenizer
- For processing small samples and precipitates
- Requires two 'AA' batteries (not included)
- Pestles and tubes, PP, DNase-, RNase- and Pyrogen free
- Cell pellets, precipitates and other solids are completely dispersed in seconds

Cat. No.	Description	Cs.
1980-50000	BioVortexer Motor	1
1980-40000	Pellet Adapter	1
1980-00005	Pestle for 0,5 ml microtubes, assorted colours	10
1980-00015	Pestle for 1,5 ml microtubes, assorted colours	10
1980-11005	Microtube, 0,5 ml, individually wrapped	100
1980-15005	Microtube, 0,5 ml, bulk packed	100
1980-21015	Microtube, 1,5 ml, individually wrapped	100
1980-25015	Microtube, 1,5 ml, bulk packed	100



# Tubes and Racks

## Centrifuge Tube, Conical Bottom

- Type 1 Class A Borosilicate Glass
- Fits into I.E.C. No. 353A centrifuge adapters
- Supplied with 38 mm rubber lined black phenolic screw cap

Cat. No.	Volume	Ø x Length (mm)	Cs.
3045-00600	590 ml	96 x 173	4
3045-00800	780 ml	96 x 173	4



## Rubber Cushion for Centrifuge Tube

- Protects tubes from breakage, provides additional stability

Cat. No.	Description	Cs.
3045-10600	Suitable for 590 ml tubes	4

## Culture Tubes

### Plain Top Culture Tube, Round Bottom

- Type 1 Class A or B Borosilicate Glass
- Use with KAP-UTS™ or Stainless Steel Closures (page 15)

Cat. No.	Description glass type	Ø x Length (mm)	Closure (mm)	Cs.
2010-25100	Class B	25 x 100	25	144
2010-25150	Class B	25 x 150	25	144
2011-13100	Class A	13 x 100	13	288
2011-16125	Class A	16 x 125	16	144
2011-18150	Class A	18 x 150	18	144
2011-25150	Class A	25 x 150	25	72
2111-38200	Class A	38 x 200	38	36



### Gas Fermentation Tube, Round Bottom, Disposable

- Tubes are inverted in bottom of larger tube for collection of fermentation gases
- Made of Borosilicate Glass

Cat. No.	Ø x Length (mm)	Cs.
2040-08029	8 x 29	144



### Screw Cap Culture Tube, Round Bottom

- Type 1 Class B Borosilicate Glass
- Includes long skirted black phenolic screw cap with white rubber liner
- Bulk packs available

Cat. No.	Ø x Length (mm)	Caps	Cs.
2012-13100	13 x 100	13-415	144
2012-16150	16 x 150	15-415	144
2112-38200	38 x 200	38-415	36



## Hungate Type Anaerobic Culture Tubes

- Type 1 Class B Borosilicate Glass
- Gas tight tube designed for maintaining anaerobic conditions
- The technique developed by Hungate et.al allows maintaining anaerobic conditions by feeding and sampling through syringes
- Anaerobic culture tubes of three fully autoclavable parts
  - a) 15-415 screw cap with 9 mm opening
  - b) gas tight black butyl rubber septum stopper
  - c) culture tube with round bottom and screw thread

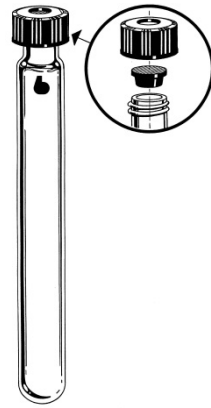

Lit.: J.M. Macy, J.E. Snellen and R.E. Hungate. "Use of Syringe Methods for anaerobics". Journal of Clinical Nutrition, December 1972.

Cat. No.	Description	Size (mm)	Cs.
2047-16125	Hungate culture tube complete	16 x 125	250

### Components

2047-16000	Screw cap only	15-415	250
2047-11600	Septum stopper only	13-415	250
2047-00125	Hungate culture tube only	16 x 125	250

→ For suitable racks please see page 29.

## Balch Type Anaerobe Culture Tubes with Aluminum Seal

- Gas tight tube designed for maintaining anaerobic conditions
- Useful for studies involving methane-producing bacteria
- Gas impermeable, blue butyl rubber septum type stoppers
- Type 1 Class B Borosilicate Glass

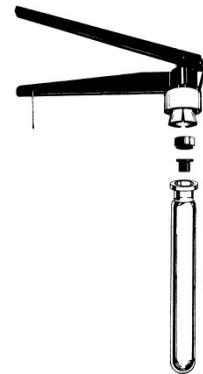

Lit.: W.E. Balch and R.S. Wolfe. "New Approach to Cultivation of Methanogenic Bacteria: 2-Mercaptoethanesulfonic Acid (HS-CoM)-Dependent Growth of Methanobacterium ruminantium in a Pressurized Atmosphere". Applied and Environmental Microbiology 32: 781-791, 1976.

Cat. No.	Description	Size (mm)	Cs.
2048-18150	Aluminum seal tube with Septum Stopper, <u>without</u> Seals	18 x 150	100

### Components:

2048-11800A	Septum Stopper only	20	100
2048-00150	Culture Tube only	18 x 150	100
2048-11020	Aluminum Seal only	20	1000

### Accessories:

2048-10020	Crimper	20	1
------------	---------	----	---

## Leighton Tissue Culture Tubes from Type 1 Class A Borosilicate Glass

Leighton culture tubes are suited for studies of pathogenic effects by viruses on cells or metabolic studies of matrix cultures carried out on cellulose sponges. They are also suitable for explant tissue cultures on cover slips.

→ For suitable Cover Slips please see page 17.

### Plain Top or Screw Cap

- Plain top (stopper size 0) or screw cap (non-toxic, rubber liner) available

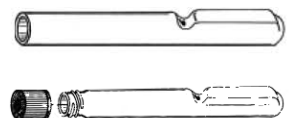

Cat. No.	Tube Size (mm)	Window Size (mm)	Cover Slip Size* (mm)	Screw Cap	Cs.
1906-16150	16 x 150	11 x 37	10,5 x 22, 10,5 x 35	Plain	36
1908-16125	16 x 125	11 x 37	9 x 9, 9 x 22, 9 x 35	15-415	36

→ Leighton Tube Racks: page 29.

### Short Style, Plain Top or Screw Cap

- Short neck for easy positioning of cover slips
- Plain top (stopper size 12) or screw cap (non-toxic, rubber liner) available
- Fits into Leighton tube rack (page 29)

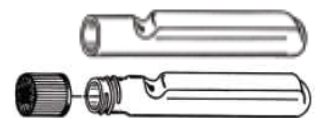

Cat. No.	Tube Size (mm)	Window Size (mm)	Cover Slip Size* (mm)	Screw Cap	Cs.
1903-19095	19 x 95	14 x 55	13 x 27, 13 x 54	Plain	36
1904-16095	16 x 93	11 x 55	9 x 9, 9 x 22, 9 x 35, 9 x 50	15-415	36
1904-19105	19 x 105	14 x 55	10,5 x 22, 10,5 x 35, 10,5 x 50	18-415	36

For cover slips, see Cat. No. 1916 (page 17)

# Stainless Steel Tube Racks

## Stainless Steel Rack for Culture Tubes

- Will not rust or deteriorate in water baths or CO<sub>2</sub> atmosphere
- Minimum order of 5 racks of the same cat. no.

Cat. No.	Size (mm)	Tubes / Rack	Approx. Size W x D x H (mm)	Cs.
2027-13012	13	12	70 x 60 x 50	1
2027-13040	13	40	165 x 70 x 55	1
2027-13072	13	72	200 x 105 x 55	1
2027-13090	13	90	230 x 125 x 60	1
2027-16024	16	24	125 x 85 x 80	1
2027-16040	16	40	200 x 85 x 80	1
2027-16048	16	48	235 x 85 x 80	1
2027-16072	16	72	235 x 120 x 80	1
2027-16090	16	90	295 x 120 x 80	1
2027-16120	16	120	235 x 195 x 80	1
2027-16150	16	150	485 x 125 x 80	1
2027-18024	18	24	140 x 95 x 80	1
2027-18040	18	40	230 x 95 x 95	1
2027-18072	18	72	275 x 150 x 80	1
2027-20012	20 to 22	12	115 x 105 x 85	1
2027-20040	20 to 22	40	260 x 105 x 80	1
2027-20048	20 to 22	48	210 x 160 x 90	1
2027-25012	25	12	125 x 95 x 105	1
2027-25036	25	36	270 x 125 x 105	1
2027-25040	25	40	300 x 125 x 105	1
2027-25072	25	72	340 x 180 x 105	1
2027-25410	25	40	300 x 125 x 55	1
2027-38012	38	12	175 x 130 x 130	1
2027-38024	38	24	255 x 175 x 130	1
2027-38040	38	40	410 x 175 x 130	1
2027-38206	38	12	255 x 88 x 130	1



## Stainless Steel Roller Culture Tube Rack for Hungate Tubes

- Spring clip prevents tube from moving in rack
- Spot-welded to ensure rigidity and durability
- Tube size max. 16 mm Ø
- Minimum order of 5 racks of the same cat. no.

Cat. No.	Description	Cs.
2028-16064	Rack for 64 tubes	1

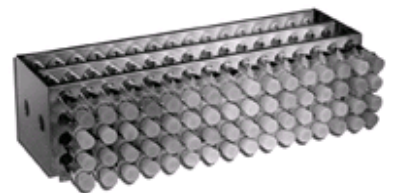

## Leighton Tube Rack

- For Leighton type culture tubes
- Hinged front of rack locks tubes into position

Cat. No.	Tube length (mm)	Tubes / Rack	Cs.
1917-16000	83 to 93	36	1
1917-00016	125 to 150	36	1



# Serological Pipettes, Canisters and Pipette Plugger

## Serological Pipettes with Cotton Plugging Top

- Type 1 Class A Borosilicate Glass
- Constricted top for cotton plugging (supplied without cotton)
- Tempered tip, to deliver, blow out
- Calibrated to tip

### Standard



Cat. No.	Size (ml)	Tolerance $\pm$ (ml)	Length (mm)	Colour Code	Cs.
1210-00201	0,2 x 0,01	0,008	330	Black	18
1210-01010	1,0 x 0,10	0,020	350	Red	18
1210-01001	1,0 x 0,01	0,020	350	Yellow	18
1210-02010	2,0 x 0,10	0,020	350	Green	18
1210-02001	2,0 x 0,01	0,020	350	White	18
1210-05010	5,0 x 0,10	0,040	350	Blue	18
1210-10010	10 x 0,10	0,060	350	Orange	18
1210-25010	25 x 0,10	0,100	400	White	18
1210-50020	50 x 0,20	0,400	685	rot	12

### Large Orifice

- 3 mm orifice for handling tissue homogenates and cell suspensions



Cat. No.	Size (ml)	Tolerance $\pm$ (ml)	Length (mm)	Colour Code	Cs.
1232-25010	25 x 0,1	0,1	400	White	18
1232-50020	50 x 0,2	0,5	470	Red	12

### “Shorties”

- Shorter length facilitates use in hoods



Cat. No.	Size (ml)	Tolerance $\pm$ (ml)	Length (mm)	Colour Code	Cs.
1226-01010	1 x 0,1	0,020	175	Red	18
1226-02010	2 x 0,1	0,025	175	Green	18
1226-05010	5 x 0,1	0,080	175	Blue	18
1226-25050	25 x 0,5	0,250	230	White	18

### “Shorties” with Large Orifice

- 3 mm orifice for handling tissue homogenates and cell suspensions
- Shorter length facilitates use in hoods



Cat. No.	Size (ml)	Tolerance $\pm$ (ml)	Length (mm)	Colour Code	Cs.
1228-05010	5 x 0,1	0,14	175	Blue	18
1228-25050	25 x 0,5	0,25	225	White	18

## Stainless Steel Pipette Cans

- Heavy gauge rectangular construction for easy stacking and storage
- Can be sterilized by autoclave or dry heat (do not exceed 180 °C)
- Inside silicone pads at top and bottom protect pipette tips

Cat. No.	Description	Size (cm)	Cs.
1217-00409	Can complete	11 x 11 x 24	1
1217-11106	Can complete	6 x 6 x 16	1
1217-11109	Can complete	6 x 6 x 24	1
1217-11116	Can complete	6 x 6 x 41	1
1217-22216	Can complete	7 x 7 x 41	1
1217-22218	Can complete	7 x 7 x 46	1



## Flat Bottom Glass Pipette Canister with Silicone Pad and 38 mm SST Closure

- Type 1 Class B Borosilicate Glass
- All components will withstand repeated dry or steam heat sterilization
- Bottom pad prevents breakage of pipettes



Cat. No.	Description	Ø x Length (mm)	Cs.
1290-00130	Canister only	38 x 130*	6
1290-00250	Canister only	38 x 250*	6
1290-00300	Canister only	38 x 300	6
1290-00430	Canister only	38 x 430	6
1290-38130	Canister complete	38 x 130*	6
1290-38250	Canister complete	38 x 250*	6
1290-38300	Canister complete	38 x 300	6
1290-38430	Canister complete	38 x 430	6

\* For "Shortie" pipettes: SST closures see 2005-series page 15

## Round Bottom Glass Pipette Canister with 38 mm SST Closure

- Type 1 Class B Borosilicate Glass
- All components will withstand repeated dry or steam heat sterilization



Cat. No.	Description	Ø x Length (mm)	Cs.
1287-00135	Canister only	38 x 135*	6
1287-00250	Canister only	38 x 250*	6
1287-00300	Canister only	38 x 300	6
1287-00430	Canister only	38 x 430	6
1287-38135	Canister complete	38 x 135*	6
1287-38250	Canister complete	38 x 250*	6
1287-38300	Canister complete	38 x 300	6
1287-38430	Canister complete	38 x 430	6

\* For "Shortie" pipettes: SST closures see 2005-series page 15



**Further pipettes and pipette cans available.**  
Please contact us!

## Pipette Plugger

- Three plugging speeds: 40, 50 or 60 pipettes per minute
- Operates in continuous or actuated mode
- Uniform plug shape insures proper plug fit
- Supplied with 1 bag of cotton roving (Cat. No. 7750-22222 see below)



Cat. No.	Description	Dimensions
7750-11220	Pipette plugger	25 x 28 x 24 cm

## Cotton Roving for Pipette Plugger

- Absorbent, 12 grain premium long-fiber cotton
- Packed two pounds (0,9 kg) coiled in plastic bag
- Plugs approximately 35.000 pipettes



Cat. No.	Description	Cs.
7750-22222	Cotton Roving	0,9 kg

# Pan Hot Shakers and Roller Drums

## Low Profile and Standard Single and Dual Pan Hot Shaker

- Ideal for:
  - DNA-protocols
  - Incubation of electrophoresis gels
  - Hybridization and temperature sensitive assays
  - Hot staining protocols
- Front mounted control panel keeps hands away from hot pan
- Locking speed control knob
- Automatic heater over-temperature shutoff
- Orbit: 2,5 cm
- Removable 12 l pan (Single model) and 5 l pans (Dual model)
- Glass dish liner (Single Pan model only)
- Stainless steel lid(s) with temperature port(s) included
- 24 V brushless motor & controller for quiet operation and low maintenance
- Temperature range: ambient +5 °C to 99 °C (+ 0,1 °C)
- Speed range: 0 - 75 oscillations per minute



Cat. No.	Description	Pan Dimensions (cm)	Dimensions (cm)
7746-42230	(a) Low profile, single pan, 12 l	47 x 27 x 10	56 x 52 x 24
7746-52230	(b) Low profile, dual pan, 2 x 5 l	25 x 20 x 10	56 x 52 x 24
7746-22220	(c) Standard, single pan, 12 l	47 x 27 x 10	56 x 56 x 33
7746-32220	(d) Standard, dual pan, 2 x 5 l	20 x 27 x 10	56 x 56 x 33



Cat. No.	Description	Dimensions (cm)
7746-12400	(e) Single pan plastic cover	55 x 33 x 12
7746-32400	(f) Dual pan plastic cover (2 required)	33 x 27 x 12
7746-10125	Flask clamp tray*, for 125 ml flasks (10 Clamps)	25 x 45
7746-10250	Flask clamp tray*, for 250 ml flasks (8 Clamps)	25 x 45
7746-10500	(h) Flask clamp tray*, for 500 ml flasks (6 Clamps)	25 x 45

\*Use with single pan model only

## Roller Drum with Digital Display

- Digital speed display (1,4 cm LCD) and locking speed knob
- Models with different speed ranges: 0,5 to 15 rpm or 2,0 to 60 rpm
- Adjustable foot for 0° to 7° drum tilt
- Dimensions Base only: approx. 31 x 33 x 46 cm
- Dimensions with Drum: approx. 46 x 33 x 61 cm

Cat. No.	Description
7736-31230	Base only, 2,0 - 60 rpm
7736-41230	Base only, 0,5 - 15 rpm
<b>Suitable Roller Drums</b>	
7736-20164	Drum only, 164-position for 16 mm Ø tubes
7736-20351	Drum only, 351-position for 16 mm Ø tubes
7736-20025	Drum only, 156-position for 25 mm Ø tubes
7736-20050	Drum only, 128-position for 30 mm Ø tubes



## Low Profile Roller Drum with Digital Display

- Digital speed display (1,4 cm LCD) and locking speed knob
- Models with different speed ranges: 0,5 to 15 rpm or 2,0 to 60 rpm
- Adjustable foot for 0° to 7° drum tilt
- Dimensions Base only: approx. 31 x 33 x 37 cm
- Dimensions with Drum: approx. 31 x 33 x 43 cm

Cat. No.	Description
7736-51230	Base only, Low Profile, 2,0 - 60 rpm
7736-61230	Base only, Low Profile, 0,5 - 15 rpm
<b>Suitable Roller Drums</b>	
7736-21106	Drum only, 106-position for 18 mm Ø tubes
7736-21060	Drum only, 60-position for 25 mm Ø tubes





# Rockers and Shakers “Back-to-Basics”

## Simple, Cost Effective Basic Models

The “Back-to-Basics”-series shakers are designed as a cost effective and simple solution for standard light duty procedures.

### Orbital Shaker

Designed for light duty procedures requiring orbital movement.

Speed range: 10-200 rpm

Orbit: 2,54 cm

Maximum load: 4 kg – evenly distributed

Dimensions (Base): 25 x 25 x 12,5 cm

Cat. No.	Description
7677-10230	Orbital shaker, base only
7740-01010	25 cm x 25 cm platform tray with mat
7740-01212	31 cm x 31 cm platform tray with mat
7740-02525	25 cm x 25 cm SST platform tray (for use with sticky strip tape)
7740-40000	Sticky strip tape for SST platform trays



### Reciprocating Shaker

Designed for light duty procedures requiring reciprocating stroke movement.

Speed range: 10-200 Cycles/Min.

Stroke: 2,54 cm

Maximum load: 4 kg – evenly distributed

Dimensions (Base): 25 x 25 x 12,5 cm

Cat. No.	Description
7677-30230	Reciprocating shaker, base only
7677-31010	25 cm x 25 cm platform tray with mat
7677-32010	25 cm x 25 cm SST platform tray (for use with sticky strip tape)
7740-40000	Sticky strip tape for SST platform trays



### Digital Display Rocker

- 24 V brushless low maintenance DC motor and speed controller
- Range of rotation: 0° - 12°
- Locking speed knob and digital display readout
- Peg & grommet tray attachment accepts all Bellco standard trays
- Speed range: 0 - 30 rocks/minute
- Timer: 3 to 120 minutes or continuous rocking action
- Maximum load: 9 kg



7743-10230

Cat. No.	Description	Dimensions (cm)
7743-10230	Digital Rocker, base only	approx. 33 x 31 x 14

Trays and platforms: see below

### Digital Display Orbital Shaker

- 24 V brushless low maintenance DC motor and speed controller
- Orbit: 2,5 cm
- Locking speed knob and digital display readout
- Peg & grommet tray attachment accepts all Bellco standard trays
- Speed range: 10 – 350 rpm
- Timer: 3 to 120 minutes or continuous rocking action
- Maximum load: 9 kg



7644-10230

Cat. No.	Description	Dimensions (cm)
7644-10230	Orbital Shaker, base only	approx. 33 x 31 x 14
7743-12012	Platform with 3 dividers	approx. 31 x 31 x 9
7743-12020	Platform with 5 dividers	approx. 31 x 51 x 9
7743-20020	Platform with 5 dividers	approx. 51 x 51 x 9



7743-20020

## Mini-Orbital Shaker

- Digital Display 1,4 cm LCD readout
- Locking speed knob
- Low profile space-saving chassis with mounting flanges
- Peg & grommet tray attachment
- Orbit: 1,59 mm
- Speed range: 40 – 1550 rpm\*
- Timer: 3 to 120 minutes or continuous shaking action
- Working environment: 4 °C - 50 °C, relative humidity 95% maximal
- Maximum load: 9 kg
- Dimensions (Base only): 35 x 37 x 14 cm



Cat. No.	Description
7644-20230	Digital Mini-Orbital Shaker, base only
7644-12012	Microplate tray with cover for 24 plates (30 x 30 cm)
7743-12012	Flask locking tray, 3 dividers (30 x 30 cm)

\* When operated at speeds in excess of 800 rpm, the shaker should be mounted to a fixed surface using the mounting flanges. Failure to do so may cause the unit to 'walk' at high speeds.



## Accessories for Rockers and Shakers

### Platform Trays

- Fits 7740/7743 series Rockers and 7744/7644 series Shakers

Cat. No.	Description
7740-01010	Platform tray with mat, 25 x 25 cm
7740-01014	Platform tray with mat, 25 x 35 cm
7740-01212	Platform tray with mat, 30 x 30 cm
7740-02020	Platform tray with mat, 51 x 51 cm

7740-02525	Stainless steel tray, 25 x 25 cm
7740-02535	Stainless steel tray, 25 x 35 cm
7740-03030	Stainless steel tray, 30 x 30 cm
7740-05151	Stainless steel tray, 51 x 51 cm

7740-40000 Sticky strip tape for SST platform trays



### Stackable Trays

- Fits 7740 to 7743 series Rocker Platforms only
- Not recommended for Shakers

Cat. No.	Description
7740-00010	Stackable trays with spacers, for 25 x 25 cm trays
7740-00020	Stackable trays with spacers, for 51 x 51 cm trays
7740-00030	Three-tier tray with 5,08 cm clearance between trays (28 x 18 x 13 cm)



### Platforms with Dividers

- Fits 7743-10230 series Rockers and 7644-10230 series Shakers

Cat. No.	Description
7743-12012	Platform with 3 dividers, 31 x 31 x 9 cm
7743-12020	Platform with 5 dividers, 31 x 51 x 9 cm
7743-20020	Platform with 5 dividers, 51 x 51 x 9 cm



### Flask Clamps and Universal Platforms for Shakers

- Flask trays fit on top of orbital shaker standard tray platforms
- SST clamps for Bellco Erlenmeyer flasks

Cat. No.	Trays
7744-17010	25 x 25 cm
7744-17020	51 x 51 cm

Cat. No.	Flask Clamps	Positions	
		7744-17010	7744-17020
7744-16025	25 ml	16	49
7744-16050	50 ml	16	49
7744-16125	125 ml	9	25
7744-16250	250 ml	5	16
7744-16500	500 ml	4	9
7744-16100	1000 ml	4	9
7744-16200	2000 ml	2	4



# Hybridization Ovens and Accessories

## Micro Autoblots® Hybridization Oven

- **Fixed** rotation speed: approx. 7,5 rpm
- Temperature Range: ambient +5 °C to 99 °C
- 4-Position rotisserie accepts 8 short or 4 long, 35 mm Ø bottles
- Includes 1 case of 35 mm hybridization bottles and 1 case of large nylon mesh 7910-02026
- Exterior dimensions (W x D x H): approx. 35 x 42 x 32 cm
- Interior dimensions (W x D x H): approx. 18 x 37 x 20 cm

Cat. No.	Description
7930-00220	Hybridization oven with 4-position rotisserie
7930-01230	Hybridization oven without rotisserie



7930-00220

## Mini Autoblots® Hybridization Oven

- **Variable** rotation speed: 0 to 80 rpm
- Temperature Range: ambient +5 °C to 99 °C
- Programmable temperature controller for optimal performance
- 6-position rotisserie accepts 12 short or 6 long, 35 mm Ø bottles
- Includes 1 case of 35 mm hybridization bottles and 1 case of large nylon mesh 7910-02026
- Exterior dimensions (W x D x H): approx. 35 x 42 x 32 cm
- Interior dimensions (W x D x H): approx. 18 x 37 x 20 cm

Cat. No.	Description
7930-10220	Hybridization oven with 6-position rotisserie
7930-11230	Hybridization oven without rotisserie



7930-10220

## Accessories for Hybridization Oven

Cat. No.	Description	Cs.
7930-20100	4-position rotisserie for 35 mm tubes	1
7930-30100	6-position rotisserie for 35 mm tubes	1
7910-70100	8-position rotisserie for 70 mm tubes (for Mega Hybridization Oven only)	1
7910-02026	Large nylon mesh, 23 x 23 cm	5
7910-02024	Large nylon mesh, 23 x 23 cm	20
7910-15005	Small nylon mesh, 15 x 10 cm	5
7910-15010	Small nylon mesh, 15 x 10 cm	20
7930-50100	Optional rocker platform for hybridization ovens, stainless steel, 3 settings from 2,5° to 6°, dimensions 29 x 16 cm, adapts existing rotisserie hardware	1

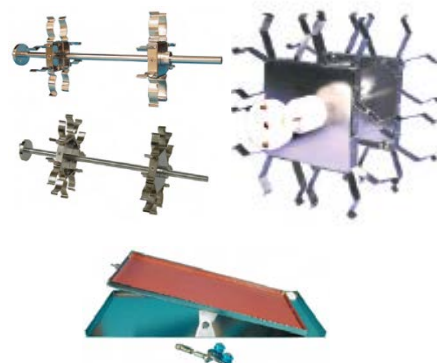

## Autoblots® Hybridization Bottles

- Type 1 Class A Borosilicate Glass
- Designed for blotting procedures for DNA/RNA
- Includes red PBT high temperature cap (except 70 mm Ø)

Cat. No.	Length x Ø (mm)	Capacity (ml)	Cs.
7910-35300	300 x 35	200	2
7910-35225	225 x 35	120	2
7910-35150	150 x 35	50	2
7910-35010	100 x 35	50	2
7910-70300	300 x 70 (for Mega Hybridization Oven only)	700	2



# Bellco Roller Bottles for Cell Culture Applications

Borosilicate Glass, Type 1, Class A  
11 cm dia.

## Roller Bottle with GL45 Linerless Screw Cap

- PP pouring ring allows drip free pouring and protects rim
- Replacement cap: 5637-00045, pouring ring: 5637-10045 (page 10)



Cat. No.	Growth Area (cm <sup>2</sup> )	Ø x Length (mm)	Screw Cap size	Cs.
7715-45585	1585	110 x 570	GL 45	2

## Roller Bottle with 38 mm Rubber Lined Screw Cap

- 38 mm long skirted, black phenolic screw cap with non-toxic rubber liner
- Replacement cap: 2029-00038 (page 14)



Cat. No.	Growth Area (cm <sup>2</sup> )	Ø x Length (mm)	Screw Cap size	Cs.
7730-38285	670	110 x 285	38-415	2
7730-38440	1170	110 x 440	38-415	2
7730-38490	1330	110 x 490	38-415	2
7730-38585	1585	110 x 570	38-415	2

## Roller Bottles with 51 mm Rubber Lined Screw Cap

- Large mouth facilitates cell harvesting
- Replacement cap: 2029-00051 (page 14)



Cat. No.	Growth Area (cm <sup>2</sup> )	Ø x Length (mm)	Screw Cap size	Cs.
7730-51270	670	110 x 270	51-400	2
7730-51475	1330	110 x 475	51-400	2
7730-51585	1585	110 x 570	51-400	2

## Roller Bottles from Borosilicate Glass (12 cm diameter)

### Wide Roller Bottles with 51 mm Rubber Lined Screw Cap

- Indented bottom for placement of two bottles on a standard roller
- Increased Diameter for increased area
- Replacement cap: 2029-00051 (page 14)



Cat. No.	Growth Area (cm <sup>2</sup> )	Ø x Length (mm)	Screw Cap size	Cs.
7730-51120	835	120 x 285	51-400	2



suitable Roller Apparatus - please see pages 37 – 39

# Roller Apparatus and large Roll-In Incubators

Bellco's Cell Production Roller Apparatus are ideally suited to perform pilot scale experiments or gear up for high volume production. The product line ranges from the two-position economy model to an 88 position high-production unit. The process-controlled Roller Apparatus can interface with computers. The Sci/ERA™ units have special alarm and safety systems. All models feature ramped bottle stops for easy bottle removal, keyed roller shafts to prevent slippage, and removable rollers for simple maintenance. Rollers are manufactured of a non-transferring, chemical resistant rubber (EDPM) compound and are mounted on ball-bearing shafts. The Bellco Roller Apparatus units can be used at environmental conditions of 4 °C to 50 °C and a non-condensing, relative humidity of 0 to 90 %.

## Modular Roller Apparatus, with or without Alarm System (Sci/ERA™)

- Modular construction of a base and up to 8 separate decks (5 positions per deck)
- Speed range: 0.1 to 4.0 rpm (optional Slow Speed Kits available on request)
- Accepts glass or plastic roller bottles with 11 to 12 cm outer diameter and up to 57 cm total length (roller length 51 cm)
- Clearance between decks: 13.4 cm

### Standard units:

- Analog speed indicator and a locking speed control knob

### Sci/ERA™ units:

- Digital speed indicator and a locking speed control knob
- All position drive
- Audible and visual alarm system with remote jack for interfacing with alarm systems or computers
- Stand-by drive and alarm system: A redundant stand-by motor is started in case of mechanical or motor fault of the primary motor
- Battery back-up: up to 18 hours of continuous operation during power failure (depending on load and rpm)



Base and 2 Decks,  
Standard unit



Base and 8 Decks,  
Sci/ERA™ unit

## Standard

Cat. No.	Description	Positions	Dimensions (w x d x h)
7630-75220	Base only	5	approx. 81 x 63 x 46 cm
7630-75221	Base and 1 Deck	10	approx. 81 x 63 x 64 cm
7630-75222	Base and 2 Decks	15	approx. 81 x 63 x 82 cm
7630-75223	Base and 3 Decks	20	approx. 81 x 63 x 100 cm
7630-75224	Base and 4 Decks	25	approx. 81 x 63 x 118 cm
7630-75225	Base and 5 Decks	30	approx. 81 x 63 x 136 cm
7630-75226	Base and 6 Decks	35	approx. 81 x 63 x 154 cm
7630-75227	Base and 7 Decks	40	approx. 81 x 63 x 172 cm
7630-75228	Base and 8 Decks	45	approx. 81 x 63 x 189 cm
7630-75010	Deck only	5	approx. 81 x 63 x 18 cm
7630-50555	All position drive, recommended for use with plastic bottles		

## Sci/ERA™

Cat. No.	Description	Positions	Dimensions (w x d x h)
7630-85220	Base only	5	approx. 81 x 63 x 46 cm
7630-85221	Base and 1 Deck	10	approx. 81 x 63 x 64 cm
7630-85222	Base and 2 Decks	15	approx. 81 x 63 x 82 cm
7630-85223	Base and 3 Decks	20	approx. 81 x 63 x 100 cm
7630-85224	Base and 4 Decks	25	approx. 81 x 63 x 118 cm
7630-85225	Base and 5 Decks	30	approx. 81 x 63 x 136 cm
7630-85226	Base and 6 Decks	35	approx. 81 x 63 x 154 cm
7630-85227	Base and 7 Decks	40	approx. 81 x 63 x 172 cm
7630-85228	Base and 8 Decks	45	approx. 81 x 63 x 189 cm
7630-85010	Deck only	5	approx. 81 x 63 x 18 cm
7630-60666	Slow Speed Kit for 0.100 to 2.0 rpm		
7630-70777	Slow Speed Kit for 0.085 to 1.7 rpm		

## Roller Apparatus with Alarm System (Sci/ERA™), fixed frame

- Fixed Frame Roller Apparatus with 9 or 10 Decks
- Features please see page 1, Slow Speed Kits available

Cat. No.	Description	Positions	Dimensions (w x d x h)
7630-82509	9 Decks	45	approx. 81 x 63 x 189 cm
7630-82510*	10 Decks	50	approx. 81 x 63 x 213 cm

\* This unit does not fit inside Roll-In Incubators

## Top Drive and Bottom Drive Roller Apparatus, fixed frame

### Standard units:

- Brushless motor & controller for smooth operation and easy maintenance
- Speed range: 0.3 to 9.0 rpm
- Rotation switch for CW and CCW operation
- All position drive
- Digital display
- Accepts glass or plastic roller bottles with 11 to 12 cm outer diameter and up to 57 cm total length (roller length 51 cm)
- Clearance between decks: 13.4 cm
- Front locking castors

### Process-controlled units:

- RS485 network port (RS232 and 4-20 mA also available on request)

### Battery Back-up:

- Up to 18 hours of continuous operation during power failure (depending on load and rpm)
- Battery level indicator flashes during battery mode

### Optional Motion Alarm (factory installation only):

- Audible and visual alarm system with remote jack for interfacing with alarm systems or computers

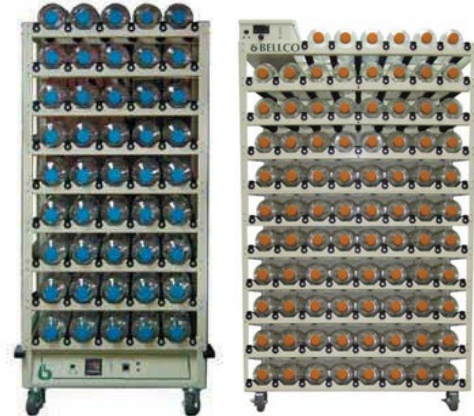

Bottom Drive and Top Drive Roller Apparatus

## Top Drive Roller Apparatus

Standard	Decks / Positions	Dimensions (w x d x h)	Battery Back-up
7440-10230	11 / 53	approx. 81 x 63 x 193 cm	no
7440-20230	11 / 53	approx. 81 x 63 x 193 cm	yes
7460-10230	11 / 86	approx. 122 x 63 x 193 cm	no
7460-20230	11 / 86	approx. 122 x 63 x 193 cm	yes
Process-controlled	Decks / Positions	Dimensions (w x d x h)	Battery Back-up
7400-10230	11 / 53	approx. 81 x 63 x 193 cm	no
7400-20230	11 / 53	approx. 81 x 63 x 193 cm	yes
7420-10230	11 / 86	approx. 122 x 63 x 193 cm	no
7420-20230	11 / 86	approx. 122 x 63 x 193 cm	yes
7400-11111	Motion Alarm for Top Drive Roller Apparatus		

## Bottom Drive Roller Apparatus

Standard	Decks / Positions	Dimensions (w x d x h)	Battery Back-up
7370-08230	8 / 40	approx. 81 x 63 x 150 cm	no
7380-08230	8 / 40	approx. 81 x 63 x 150 cm	yes
7340-09230	9 / 45	approx. 81 x 63 x 170 cm	no
7360-09230	9 / 45	approx. 81 x 63 x 170 cm	yes
7340-10230	10 / 50	approx. 81 x 63 x 188 cm	no
7360-10230	10 / 50	approx. 81 x 63 x 188 cm	yes
Process-controlled	Decks / Positions	Dimensions (w x d x h)	Battery Back-up
7375-08230	8 / 40	approx. 81 x 63 x 150 cm	no
7385-08230	8 / 40	approx. 81 x 63 x 150 cm	yes
7300-09230	9 / 45	approx. 81 x 63 x 170 cm	no
7320-09230	9 / 45	approx. 81 x 63 x 170 cm	yes
7300-10230	10 / 50	approx. 81 x 63 x 188 cm	no
7320-10230	10 / 50	approx. 81 x 63 x 188 cm	yes
7440-11111	Motion Alarm for Bottom Drive Roller Apparatus		

## Benchtop Roller Apparatus, modular and fixed frame

- All-Position Drive
- Accepts Bellco glass and plastic roller bottles with 11 cm to 12 cm outer diameter and 28.5 cm length (roller length 22 cm)
- Clearance between decks: 13.4 cm

### 10 Position Roller Apparatus 7630-20230 additionally:

- Digital Display
- Rotation switch for CW and CCW operation



## Modular units

Cat. No.	Description	Speed	Positions	Dimensions (w x d x h)
7622-01220	Base	0.25 to 3.00 rpm	2	approx. 36 x 33 x 27 cm
7622-02220	Base and 1 Deck	0.25 to 3.00 rpm	4	approx. 36 x 33 x 45 cm
7632-00230	Base	0.10 to 4.00 rpm	2	approx. 34 x 33 x 27 cm
7632-10000	Deck (max. 2)		2	approx. 34 x 33 x 18 cm

## Fixed frame unit

Cat. No.	Description	Speed	Positions	Dimensions (w x d x h)
7621-20230	Base and 1 Deck	0.30 to 10.00 rpm	10	approx. 74 x 32 x 42 cm

## Benchtop Incubator for Roller Apparatus with 4 or 10 positions (max. 2 decks)

- Temperature range: 5 °C above ambient to 50 °C
- Temperature uniformity:  $\pm 1.0$  °C at 37 °C
- Exterior dimensions (w x d x h): approx. 90 x 54 x 77 cm
- Chamber dimensions (w x d x h): approx. 75 x 35 x 50 cm (interior) (139 l)
- Temperature alarm with remote jack
- One interior electrical outlet



Cat. No.	Description
7728-10230	Incubator with Solid Door
7728-20230	Incubator with Glass Door
7728-00047	Optional Shelf Only

## Standard Roll-In Incubator



These incubators provide high chamber capacities while minimizing the amount of floor space used. Both models incorporate a microprocessor controller to achieve precise temperature uniformity. An independent, secondary temperature controller offers the added security of over-temperature protection. The chamber floors are reinforced to support roller apparatus or shakers. Both models are supplied with six shelves capable of supporting the weight of benchtop instruments. Incubators can be used between 15 °C and 30 °C at an ambient relative humidity of max. 80 %.



- Extra large, with viewing window
- Stainless steel interior and shelves
- Guide rails for roller apparatus
- Temperature range: 8 °C above ambient to 70 °C
- Temperature uniformity:  $\pm 0.8$  °C at 37 °C
- Temperature stability:  $\pm 0.1$  °C
- Over-temperature alarm
- Air jacket
- 1 Interior electrical outlet
- 1 Access port

Cat. No.	Chamber Volume (l)	Shelves supplied/max.	Ext. Dimensions (w x d x h)	Internal Dimensions (w x d x h)
SMI31-2	872	6 / 16	approx. 97 x 83 x 186 cm	approx. 82 x 66 x 162 cm
SMI39-2	1092	6 / 20	approx. 106 x 84 x 229 cm	approx. 90 x 66 x 193 cm

## Large Capacity CO<sub>2</sub> Roll-In Incubator



Shellab/Sheldon large capacity CO<sub>2</sub> incubators are ideal for use with shelves or in combination with roller apparatus from Bellco Glass for high-volume tissue culture applications. They provide a precisely controlled, accurate, pure environment throughout the culturing process. The incubators can be used between 15 °C and 30 °C at an ambient relative humidity of max. 80 %.



- Extra large CO<sub>2</sub> incubator with guide rails for roller apparatus
- All stainless steel interior and shelves (6 shelves provided)
- Microprocessor temperature control
- Temperature Range: 8 °C above ambient to 60 °C
- Temperature Uniformity:  $\pm 0.5$  °C at 37 °C
- Temperature stability:  $\pm 0.1$  °C
- Independent over-temperature protection
- Infrared CO<sub>2</sub> sensor, CO<sub>2</sub> Range: 0 to 20 %
- CO<sub>2</sub> Recovery Rate: < 5 minutes
- Air jacketed
- USB-style RS232 serial port and 4-20 mA output for data logging of CO<sub>2</sub> level and temperature
- 1 Interior electrical outlet
- 1 Access port

Cat. No.	Chamber Volume (l)	Shelves supplied/max.	Ext. Dimensions (w x d x h)	Internal Dimensions (w x d x h)
SCO31-2	891	6 / 30	approx. 101 x 86 x 194 cm	approx. 83 x 66 x 160 cm
SCO40-2	1118	6 / 30	approx. 107 x 85 x 224 cm	approx. 88 x 65 x 193 cm
SCO58-2	1641	6 / 30	approx. 130 x 114 x 206 cm	approx. 109 x 88 x 171 cm

## Refrigerated Roll-In Incubators (large and small versions)

These incubators are ideal for the cultivation of temperature sensitive cells in a controlled environment.

- Temperature range: 20 - 50 °C
- Temperature uniformity:  $\pm 0.5$  °C cooling; at  $\pm 1.0$  °C heating
- Microprocessor PID temperature controller
- Forced air circulation for even temperature distribution
- Interior electrical power outlets (2 - 4) in chamber
- Control panel with power switch, convenience outlet, safety thermostat
- Refrigeration switch and temperature controller
- For easy loading and accommodation of small and large roller apparatus (up to 9 decks for fixed frame or "base +7 decks" for modular units)
- Optional stainless steel shelves or Ultra Vented shelves (on request)
- Temperature recorder available for Large Capacity Roll-In Incubators



Cat. No.	Chamber Volume (l)	Door variant	Ext. Dimensions (w x d x h)	Internal Dimensions (w x d x h)
7728-01230	1075	Single window	approx. 104 x 81 x 221 cm	approx. 89 x 66 x 178 cm
7728-51230	1075	Double window	approx. 104 x 81 x 221 cm	approx. 89 x 66 x 178 cm
7728-04230	595	Single window	approx. 104 x 79 x 130 cm	approx. 88 x 65 x 87 cm

***Also available: Bellco Glass cell production device combination:***

***Large capacity Digital Roller Apparatus with 88 bottle positions and suitable Extra Large Roll-In CO<sub>2</sub> Incubator with touch screen displays.***  
**Please enquire for further details.**